



SWITCH TO A BETTER WORLD



WELCOME
TO
THE MOST
LUXURIOUS
EXPERIENCE

Suniel Shetty
(Brand Ambassador)



The Company

In 2002 the organization has appeared with an objective to make things easier and life simpler. GM has believed that the hard working world deserves a less complex life. And the human struggles need to decrease through simple access to automation.

GM redefined switch manufacturing in India. From switches to home automation, for more than a decade we have been catering "better lives" to our customers across the country. By introducing innovation, GM incorporates advanced and imaginative products that transformed people's lives tremendously. At GM, we believe in constant innovation and we are the market leaders in switches and other home electrical accessories.

Founded in 2002, we have been in the forefront of home electrical solutions. We made space for good technology for every home by introducing some revolutionary products like new generation switches, home automation, Bluetooth music players, home security products, switchgears and brilliant contemporary range in LED lighting and luminaires.

Our innovations are the result of a strong research & development team, which is further complimented by an equally dedicated, and capable product design team. Our state-of-the-art manufacturing facility is spread around 2.5 lakh square feet with the most efficient and high-grade machinery that produces the finest quality products that carry the GM logo.



Welcome to the most luxurious experience

I was always fascinated by GM's idea of luxury and therefore this successful association. Luxury is one brilliant idea. That one idea that further helps to elaborate creating functional products. GM understands how important experiences are, and that is what we inculcate in our designs. FourFive is about classic timeless forms to unconventional designs, we find inspiration from everything.

Being GM's brand ambassador, I believe that luxury is that state of mind where experiences aid in creating the right mind-set. GM's motive of offering convenience to a million, got my instant consent of collaboration. Moreover, with our passion towards our work, the excellence in creating products of exceptional quality, I can relate with my belief of giving it my all for that one perfect shot.

With all my heart, I welcome you to have the most luxurious FourFive experience.

Suniel Shetty
(Brand Ambassador)





Our love for your home

SMART SWITCHES

We have designed a very special product for your home. It is called luxury. And it's the first thing that will strike you with its unmistakable appearance.



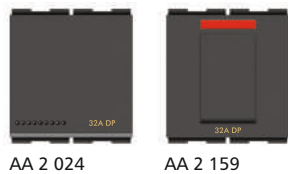
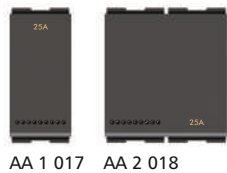
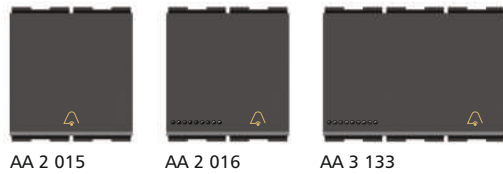
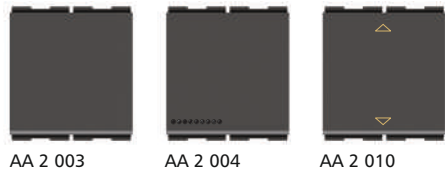

CODE	HSN CODE	ITEM	MRP ₹		
			GLOSSY WHITE	ELE. GREY GRAPHITE MAGNESIA STD./MST. BLACK GOLD	20/600 PKG.
10AX SWITCHES 240V~ 1 MODULE					
AA 1 001	8536	1 Way Switch	70.00	79.00	20/600
AA 1 002	8536	1 Way Switch with Ind. (LED)	147.00	161.00	20/600
AA 1 009	8536	2 Way Switch	145.00	160.00	20/600
AA 1 013	8536	Bell Push Switch	152.00	174.00	20/600
AA 1 014	8536	Bell Push Switch with Ind. (LED)	179.00	196.00	20/600
6AX SWITCH 240V~ 1 MODULE					
AA 1 401	8536	1 Way Switch	70.00	79.00	20/600
10AX SWITCHES 240V~ 2 & 3 MODULE					
AA 2 003	8536	1 Way Switch	165.00	182.00	10/300
AA 2 004	8536	1 Way Switch with Ind. (LED)	187.00	207.00	10/300
AA 2 010	8536	2 Way Switch	209.00	229.00	10/300
AA 2 015	8536	Bell Push Switch	209.00	229.00	10/300
AA 2 016	8536	Bell Push Switch with Ind. (LED)	231.00	254.00	10/300
AA 3 133	8536	Bell Push Switch with Ind. (LED)	270.00	298.00	10/300
20AMP SWITCHES 240V~ 1 MODULE					
AA 1 005	8536	1 Way Switch	197.00	216.00	20/600
AA 1 006	8536	1 Way Switch with Ind. (LED)	223.00	245.00	20/600
AA 1 011	8536	2 Way Switch	225.00	248.00	20/600
20AMP SWITCHES 240V~ 2 MODULE					
AA 2 007	8536	1 Way Switch	231.00	253.00	10/300
AA 2 008	8536	1 Way Switch with Ind. (LED)	257.00	282.00	10/300
AA 2 012	8536	2 Way Switch	277.00	304.00	10/300
25AMP SWITCHES 240V~ 1 & 2 MODULE					
AA 1 017	8536	1 Way Switch with Ind. (LED)	235.00	260.00	20/600
AA 2 018	8536	1 Way Switch with Ind. (LED)	294.00	318.00	10/300
32AMP DOUBLE POLE SWITCHES 240V~ 2 MODULE					
AA 2 024	8536	DP Switch with Ind. (LED)	391.00	430.00	10/300
AA 2 159	8536	DP Switch with Ind. (LED)	401.00	435.00	10/300
6A BELL PUSH SWITCH 240V~ 50Hz - 2 MODULE					
AA 2 025	8536	Bell Push Switch with Luminous Name Plate, LED circuit and Diffuser	277.00	304.00	10/300

CODE	HSN CODE	ITEM	MRP ₹		
			GLOSSY WHITE	ELE. GREY GRAPHITE MAGNESIA STD./ MST. BLACK GOLD	MST. PKG.
6AX ZENOVA SWITCHES 240V~ 1 MODULE					
AA 1 331	8536	1 Way Switch	106.00	119.00	20/600
AA 1 332	8536	1 Way Switch with Indicator (LED)	160.00	175.00	20/600
AA 1 333	8536	2 Way Switch	151.00	166.00	20/600
AA 1 334	8536	Bell Push Switch with Indicator (LED)	210.00	229.00	20/600
6AX ZENOVA SWITCHES 240V~ 2 MODULE					
AA 2 335	8536	1 Way Switch	183.00	203.00	10/300
AA 2 336	8536	1 Way Switch with Indicator (LED)	215.00	238.00	10/300
AA 2 337	8536	2 Way Switch	203.00	224.00	10/300
AA 2 338	8536	Bell Push Switch with Indicator (LED)	288.00	318.00	10/300
16AX ZENOVA SWITCHES 240V~ 1 MODULE					
AA 1 339	8536	1 Way Switch	177.00	194.00	20/600
AA 1 340	8536	1 Way Switch with Indicator (LED)	210.00	231.00	20/600
AA 1 341	8536	2 Way Switch	223.00	257.00	20/600
16AX ZENOVA SWITCHES 240V~ 2 MODULE					
AA 2 342	8536	1 Way Switch	246.00	271.00	10/300
AA 2 343	8536	1 Way Switch with Indicator (LED)	279.00	307.00	10/300
AA 2 344	8536	2 Way Switch	298.00	328.00	10/300
32AMP ZENOVA DOUBLE POLE SWITCH 240V~ 2 MODULE					
AA 2 346	8536	DP Switch with Indicator (LED)	583.00	642.00	10/300

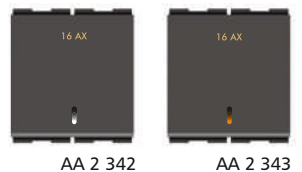
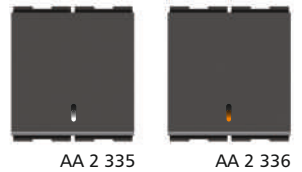
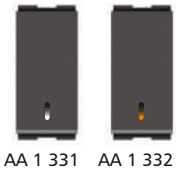

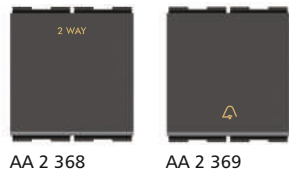

CODE	HSN CODE	ITEM	MRP ₹		
			GLOSSY WHITE	ELE. GREY GRAPHITE MAGNESIA BLACK GOLD	STD./ MST. PKG.
10AX ZICONO SWITCHES 240V~ 1 MODULE					
AA 1 361	8536	1 Way Switch	81.00	90.00	20/600
AA 1 362	8536	1 Way Switch with Indicator (LED)	154.00	169.00	20/600
AA 1 363	8536	2 Way Switch	154.00	169.00	20/600
AA 1 364	8536	Bell Push Switch	159.00	175.00	20/600
AA 1 365	8536	Bell Push Switch with Indicator (LED)	177.00	195.00	20/600
10AX ZICONO SWITCHES 240V~ 2 MODULE					
AA 2 366	8536	1 Way Switch	172.00	189.00	10/300
AA 2 367	8536	1 Way Switch with Indicator (LED)	195.00	212.00	10/300
AA 2 368	8536	2 Way Switch	207.00	228.00	10/300
AA 2 369	8536	Bell Push Switch	200.00	220.00	10/300
AA 2 370	8536	Bell Push Switch with Indicator (LED)	230.00	253.00	10/300
20AMP ZICONO SWITCHES 240V~ 1 MODULE					
AA 1 371	8536	1 Way Switch	200.00	220.00	20/600
AA 1 372	8536	1 Way Switch with Indicator (LED)	224.00	248.00	20/600
AA 1 373	8536	2 Way Switch	224.00	248.00	20/600
20AMP ZICONO SWITCHES 240V~ 2 MODULE					
AA 2 374	8536	1 Way Switch	230.00	253.00	10/300
AA 2 375	8536	1 Way Switch with Indicator (LED)	260.00	285.00	10/300
AA 2 376	8536	2 Way Switch	283.00	312.00	10/300
32AMP ZICONO DOUBLE POLE SWITCHES 240V~ 2 MODULE					
AA 2 378	8536	DP Switch with Indicator (LED)	412.00	454.00	10/300
AA 2 379	8536	DP Switch with Indicator (LED)	395.00	434.00	10/300

CODE	HSN CODE	ITEM	MRP ₹		
			GLOSSY WHITE	ELE. GREY GRAPHITE MAGNESIA STD./ MST. BLACK GOLD	MST. PKG.
6AX ZIANO SWITCHES 240V~ 1 MODULE					
AA 1 621	8536	1 Way Switch	54.00	63.00	20/600
AA 1 622	8536	1 Way Switch with Indicator (LED)	102.00	119.00	20/600
AA 1 623	8536	2 Way Switch	102.00	119.00	20/600
AA 1 624	8536	Bell Push Switch	111.00	130.00	20/600
AA 1 625	8536	Bell Push Switch with Indicator (LED)	125.00	147.00	20/600
6AX ZIANO SWITCHES 240V~ 2 MODULE					
AA 2 626	8536	1 Way Switch	119.00	138.00	10/300
AA 2 627	8536	1 Way Switch with Indicator (LED)	144.00	170.00	10/300
AA 2 628	8536	2 Way Switch	144.00	170.00	10/300
AA 2 629	8536	Bell Push Switch	141.00	171.00	10/300
AA 2 630	8536	Bell Push Switch with Indicator (LED)	155.00	182.00	10/300
16AX ZIANO SWITCHES 240V~ 1 MODULE					
AA 1 631	8536	1 Way Switch	121.00	143.00	20/600
AA 1 632	8536	1 Way Switch with Indicator (LED)	161.00	191.00	20/600
AA 1 633	8536	2 Way Switch	161.00	191.00	20/600
16AX ZIANO SWITCHES 240V~ 2 MODULE					
AA 2 634	8536	1 Way Switch	155.00	180.00	10/300
AA 2 635	8536	1 Way Switch with Indicator (LED)	176.00	208.00	10/300
AA 2 636	8536	2 Way Switch	176.00	208.00	10/300
32AMP ZIANO DOUBLE POLE SWITCH 240V~ 2 MODULE					
AA 2 637	8536	DP Switch with Indicator (LED)	283.00	330.00	10/300

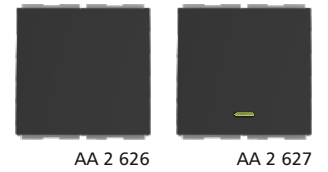

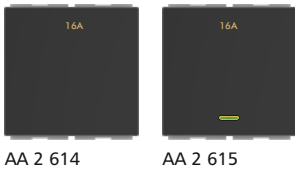
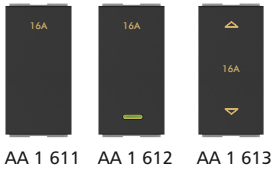
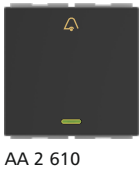
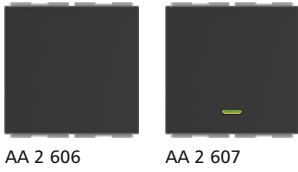
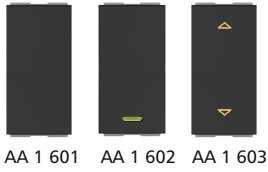

CODE	HSN CODE	ITEM	MRP ₹		
			GLOSSY WHITE	ELE. GREY GRAPHITE MAGNESIA BLACK GOLD	STD./ MST. PKG.
6AX ZURICO SWITCHES 240V~ 1 MODULE					
AA 1 601	8536	1 Way Switch	54.00	63.00	20/600
AA 1 602	8536	1 Way Switch with Indicator (LED)	104.00	122.00	20/600
AA 1 603	8536	2 Way Switch	104.00	122.00	20/600
AA 1 604	8536	Bell Push Switch	113.00	134.00	20/600
AA 1 605	8536	Bell Push Switch with Indicator (LED)	127.00	151.00	20/600
6AX ZURICO SWITCHES 240V~ 2 MODULE					
AA 2 606	8536	1 Way Switch	119.00	141.00	10/300
AA 2 607	8536	1 Way Switch with Indicator (LED)	146.00	173.00	10/300
AA 2 608	8536	2 Way Switch	146.00	173.00	10/300
AA 2 609	8536	Bell Push Switch	144.00	174.00	10/300
AA 2 610	8536	Bell Push Switch with Indicator (LED)	158.00	187.00	10/300
16AX ZURICO SWITCHES 240V~ 1 MODULE					
AA 1 611	8536	1 Way Switch	127.00	151.00	20/600
AA 1 612	8536	1 Way Switch with Indicator (LED)	164.00	195.00	20/600
AA 1 613	8536	2 Way Switch	164.00	195.00	20/600
16AX ZURICO SWITCHES 240V~ 2 MODULE					
AA 2 614	8536	1 Way Switch	158.00	184.00	10/300
AA 2 615	8536	1 Way Switch with Indicator (LED)	179.00	212.00	10/300
AA 2 616	8536	2 Way Switch	179.00	212.00	10/300
32AMP ZURICO DOUBLE POLE SWITCH 240V~ 2 MODULE					
AA 2 617	8536	DP Switch with Indicator (LED)	288.00	337.00	10/300

CODE	HSN CODE	ITEM	MRP ₹		
			GLOSSY WHITE	ELE. GREY GRAPHITE MAGNESIA STD./ MST. BLACK GOLD	MST. PKG.
6AX AER9 SWITCHES 240V~ 1 MODULE					
AA 1 431	8536	1 Way Switch	59.00	65.00	20/600
AA 1 432	8536	1 Way Switch with Indicator (LED)	110.00	122.00	20/600
AA 1 433	8536	2 Way Switch	110.00	122.00	20/600
AA 1 434	8536	Bell Push Switch	125.00	138.00	20/600
AA 1 435	8536	Bell Push Switch with Indicator (LED)	141.00	155.00	20/600
6AX AER9 SWITCHES 240V~ 2 MODULE					
AA 2 436	8536	1 Way Switch	129.00	143.00	10/300
AA 2 437	8536	1 Way Switch with Indicator (LED)	165.00	182.00	10/300
AA 2 439	8536	Bell Push Switch	165.00	182.00	10/300
AA 2 440	8536	Bell Push Switch with Indicator (LED)	180.00	198.00	10/300
16AX AER9 SWITCHES 240V~ 1 MODULE					
AA 1 441	8536	1 Way Switch	146.00	162.00	20/600
AA 1 442	8536	1 Way Switch with Indicator (LED)	176.00	192.00	20/600
AA 1 443	8536	2 Way Switch	176.00	192.00	20/600
16AX AER9 SWITCHES 240V~ 2 MODULE					
AA 2 444	8536	1 Way Switch	177.00	195.00	10/300
AA 2 445	8536	1 Way Switch with Indicator (LED)	204.00	224.00	10/300
32AMP AER9 DOUBLE POLE SWITCH 240V~ 2 MODULE					
AA 2 447	8536	DP Switch with Indicator (LED)	313.00	343.00	10/300

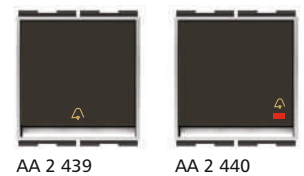
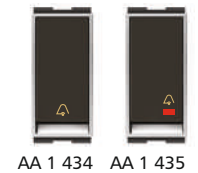

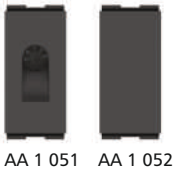
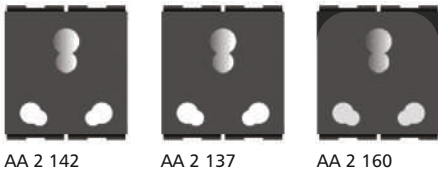
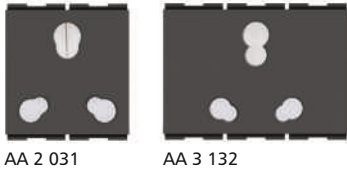
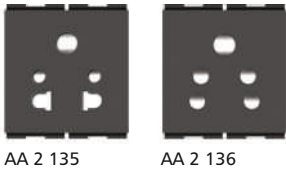
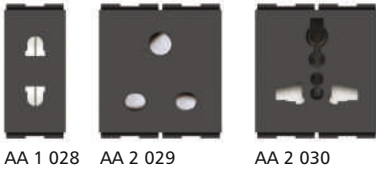
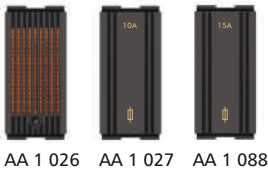

CODE	HSN CODE	ITEM	MRP ₹		
			GLOSSY WHITE	ELE. GREY GRAPHITE MAGNESIA STD./ MST. BLACK GOLD	PKG.
INDICATOR, FUSE UNITS 240V~ 1 MODULE					
AA 1 026	8536	Indicator with neon bulb holder	136.00	148.00	20/600
AA 1 027	8536	Fuse 10Amp*	180.00	198.00	20/600
AA 1 088	8536	Fuse 15Amp*	192.00	212.00	20/600
		*with glass tube ϕ 6.3 x 28mm			
6AMP / 10AMP SOCKETS 240V~ 1 & 2 MODULE					
AA 1 028	8536	6Amp 2 Pin Euro-American Socket*	129.00	143.00	20/600
AA 2 029	8536	10Amp Combined Socket*	154.00	168.00	10/300
AA 2 030	8536	13Amp International Socket*	260.00	289.00	10/300
AA 2 135	8536	6Amp Universal Socket 2/3 Pin with mobile charger socket*	169.00	185.00	10/300
AA 2 136	8536	6Amp 2 in 1 Socket*	151.00	165.00	10/300
		*with safety shutter			
6 & 16AMP / 25AMP SOCKETS 240V~ 2 & 3 MODULE					
AA 2 031	8536	6 & 16Amp Universal Socket*	287.00	316.00	10/300
AA 3 132	8536	6 & 16Amp Universal Socket*	269.00	292.00	10/300
AA 2 142	8536	6 & 16Amp Universal Socket*	287.00	316.00	10/300
AA 2 137	8536	6 & 25Amp Universal Socket*	311.00	341.00	10/300
AA 2 160	8536	6 & 16Amp Universal Socket* (Raised)	298.00	326.00	10/300
		*with safety shutter			
TV SOCKET / RJ-11 TEL JACKS - 1 MODULE					
AA 1 032	8536	TV Socket (Coaxial 40-862 MHZ Socket)	156.00	172.00	20/600
AA 1 043	8536	2 Line Jack, RJ-11 - with shutter & nam plate	167.00	184.00	20/600
AA 1 044	8536	2 Line Jack, RJ-11 with PCB	149.00	163.00	20/600
AA 1 045	8536	4 Line Jack, RJ-11 with PCB	205.00	225.00	20/600
EDP SOCKETS - 1 MODULE					
AA 1 046	8536	EDP Socket Outlet - RJ 45 [Cat 5e]*	277.00	304.00	20/600
AA 1 047	8536	EDP Socket Outlet - RJ 45 [Cat 6]*	697.00	766.00	20/600
		*with shutter, name plate & insulation - piercing terminal			
AUDIO - VIDEO SOCKETS 1 & 2 MODULE					
AA 1 145	8536	Triple RCA Socket (Audio & Video)	753.00	828.00	20/600
AA 2 144	8536	HDMI Socket	1007.00	1108.00	10/300
AA 1 146	8536	Female HD15 (VGA) Socket	360.00	396.00	20/600
CORD GRIPPER / BLANK PLATE - 1 MODULE					
AA 1 051	8536	Cable Outlet (Cord Gripper)	80.00	87.00	20/600
AA 1 052	8538	Blank Plate	29.00	32.00	50/1500

CODE	HSN CODE	ITEM	MRP ₹		
			GLOSSY WHITE	ELE. GREY GRAPHITE MAGNESIA STD./ MST. BLACK GOLD	PKG.
DIMMERS 240V~ 50Hz 1 & 2 MODULE					
AA 1 034	8533	Dimmer - 300Watt	318.00	349.00	10/450
AA 2 035	8533	Jog Dial Dimmer - 300Watt	372.00	408.00	10/300
AA 2 037	8533	Dimmer - 600Watt	410.00	450.00	10/300
STEP FAN REGULATORS 240V~ 50Hz 1 & 2 MODULE					
AA 1 039	8414	Electronic Type 4 Step Fan Regulator (Full Rotary)	487.00	535.00	10/450
AA 2 040	8414	Electronic Type 5 Step Fan Regulator	522.00	574.00	10/300
AA 2 041	8414	Electronic Type 5 Step Fan Regulator (Full Rotary)	522.00	574.00	10/300
AA 2 042	8414	Electronic Type 5 Step Fan Regulator (Full Rotary)	522.00	574.00	10/300
ELECTRONIC DOOR BELLS 240V~ 50-60Hz 2 & 3 MODULE					
AA 3 152	8531	Electronic Mantra Bell - with selectable mantras, volume control & rechargeable & replaceable battery (BL-5C Li-ion Battery, 3.7V, 1050mAh) Battery included.	822.00	903.00	5/100
AA 3 153	8531	Electronic Multitune Bell - with selectable multitune, volume control & rechargeable & replaceable battery (BL-5C Li-ion Battery, 3.7V, 1050mAh) Battery included.	822.00	903.00	5/100
AA 2 082	8531	Electronic Parrot Bell	240.00	262.00	10/300
MECHANICAL / ELECTRONIC BUZZERS 240V~ 50-60Hz 1 & 2 MODULE					
AA 1 048	8531	Mechanical Buzzer	210.00	228.00	20/600
AA 2 049	8531	Electronic Buzzer	223.00	245.00	10/300
MOSQUITO REPELLENTS 240V~ 50-60Hz 1 & 2 MODULE					
AA 1 065	8516	Ultrasonic Mosquito Repellent	242.00	262.00	20/600
AA 2 080	8516	Mosquito Repellent / Fragrance Diffuser Mat Type (Mat not included)	302.00	328.00	5/150
STEP MARKER / LIGHT FITTINGS 240V~ 50-60Hz 1 & 2 MODULE					
AA 2 060	9405	Step Marker Light - with LED	540.00	595.00	5/150
AA 2 064	9405	Light Fitting - with adjustable shutter	540.00	595.00	5/100
AA 2 033 WH	9405	Step Marker Light - with LED - White	510.00	561.00	5/150
AA 2 033 WW	9405	Step Marker Light - with LED - Warm White	510.00	561.00	5/150
AA 2 033 BL	9405	Step Marker Light - with LED - Blue	510.00	561.00	5/100
AA 2 083 WH	9405	Light Fitting - with LED - White	1123.00	1236.00	5/100
AA 2 083 WW	9405	Light Fitting - with LED - Warm White	1123.00	1236.00	5/100
AA 2 083 BL	9405	Light Fitting - with LED- Blue	1123.00	1236.00	5/100

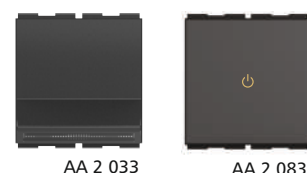
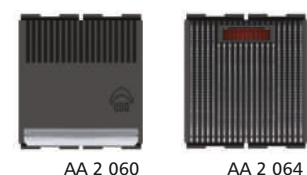
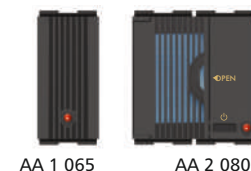
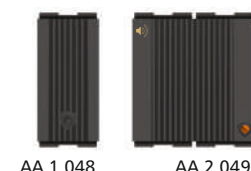
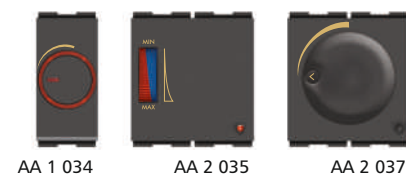

Available colours





AA 1 061 AA 2 062 AA 3 063



AA 2 057



AA 3 150



AA 2 055



AA 2 055 CG



AA 2 059 (O) AA 2 059 (W)



AA 2 059 (R) AA 2 059 (G)



AA 2 067 AA 2 154



AA 1 087 AA 2 109

CODE	HSN CODE	ITEM	MRP ₹		
			GLOSSY WHITE	ELE. GREY GRAPHITE MAGNESIA STD. BLACK GOLD	ASTD./ MST. PKG.
LIGHT FITTINGS 240V~ 50-60Hz 1, 2 & 3 MODULE					
AA 1 061	9405	Light Fitting - with high efficiency LED	716.00	788.00	5/100
AA 2 062	9405	Light Fitting - with high efficiency LED & 3 Steps Dimming Switch	1144.00	1258.00	5/100
AA 3 063	9405	Light Fitting - with high efficiency LED & 3 Steps Dimming Switch	1419.00	1561.00	5/100
EMERGENCY LIGHTS 240V~ 50-60Hz 2 & 3 MODULE					
AA 2 057	9405	Emergency Light Fitting with high luminous LED, 3 steps dimming, automatic emergency device, rechargeable & replaceable 3.6V, Li-ion battery. (Battery not included - AA 2 055 CG)	1092.00	1187.00	5/100
AA 3 150	9405	Emergency Light Fitting with high luminous LED, 3 steps dimming, automatic emergency device, rechargeable & replaceable battery. (BL-5C Li-ion Battery, 3.7V, 1050mAh) Battery included.	1723.00	1887.00	5/100
EMERGENCY PORTABLE TORCH LAMP 240V~ 50-60Hz 2 MODULE					
AA 2 055	9405	Emergency Torch Lamp (Detachable) with high luminous LED, automatic emergency device, rechargeable & replaceable 3.6V Li-ion battery. (Battery not included - AA 2 055 CG)	1330.00	1458.00	5/100
BATTERY					
AA 2 055 CG	8506	Battery Li-ion, 3.6V 300mAH	284.00	-	10/300
PRISMATIC INDICATOR UNITS 240V~ 50-60Hz 2 MODULE					
AA 2 059 -O	9405	Prismatic LED Indicator (Bulk Head Light) with orange diffuser	350.00	376.00	5/150
AA 2 059 -W	9405	Prismatic LED Indicator (Bulk Head Light) with white diffuser	350.00	376.00	5/150
AA 2 059 -R	9405	Prismatic LED Indicator (Bulk Head Light) with red diffuser	350.00	376.00	5/150
AA 2 059 -G	9405	Prismatic LED Indicator (Bulk Head Light) with green diffuser	350.00	376.00	5/150
PASSIVE INFRARED SENSORS (Movement detector) 240V~ 50-60Hz 1 & 2 MODULE					
AA 2 067	8536	Passive Infrared Sensor - 2M -with integral relay, 300W	1293.00	1405.00	5/100
AA 2 154	8536	Passive Infrared Sensor - 2M with integral relay, three modes - day, night & direct load bypass with time delay function 450W	1495.00	1611.00	5/100
AA 1 087	8536	Passive Infrared Sensor - 1M with adjustable dusk-down threshold & time delay cycle, 100W	1378.00	1495.00	5/100
AA 2 109	8536	Passive Infrared Sensor - 2M with integral relay, adjustable dusk-down threshold & time delay cycle, 300W	1452.00	1553.00	5/100

CODE	HSN CODE	ITEM	MRP ₹		
			GLOSSY WHITE	ELE. GREY GRAPHITE MAGNESIA STD./ MST. BLACK GOLD	PKG.
ANALOG & DIGITAL ALARM CLOCKS 2 & 3 MODULE					
AA 2 073	9105	Digital Alarm Clock 240V~ 50-60Hz, Equipped with in-built calendar, thermometer. With Button Cell (ML 2025) 1 nos. included	1490.00	1620.00	5/100
AA 3 072	9105	Analog Alarm Clock (Detachable) Button Cell (LR-44) 2 nos. included	499.00	549.00	5/100
DND / MAKE MY ROOM UNIT 240V~ 50-60Hz 1 & 2 MODULE					
AA 1 053	8536	Do Not Disturb / Make My Room Indicator Unit (Outside Room)	377.00	416.00	20/600
AA 2 054	8536	Do Not Disturb / Make My Room Actuator Unit (Inside Room) with door bell circuit.	435.00	478.00	10/300
BELL INDICATOR DISPLAY UNITS 240V~ 50-60Hz 1 & 6 MODULE					
AA 1 050	8536	Bell Indicator Display Unit reset switch & name plate.	332.00	366.00	20/600
AA 6 155	8536	Bell Indicator with 6 Display Units with buzzer, reset switches & name plate.	1699.00	1899.00	5/100
HOTEL KEY FOB SWITCH & KEY FOB 2 & 3 MODULE					
AA 2 074	8536	32Amp DP Switch with indicator (LED) operated by key FOB, 240V~ (Key FOB included)	658.00	725.00	5/200
AA 2 108	8538	Key FOB with name plate for product AA 2 074	118.00	128.00	20/800
AA 3 075	8536	20Amp Smart Card Operated Electronic Switch with indicator (LED) & integral relay having exit delay, 240V~ 50-60Hz	1654.00	1802.00	5/100
AA 3 075 GA	8538	Smart Card customizable for product AA 3 075* *Refer page 65 for customization & symbols	122.00	-	20/1000
SHAVER SOCKET 240V~ 50-60Hz - 3 MODULE					
AA 3 076	8536	Shaver Socket (Euro American) with isolating transformer, output 110/240V~	1791.00	1966.00	5/100
FOOT LIGHT, STEP MARKER & SIGNAGES - 3 MODULE					
AA 3 156	9405	Foot Light (LED) 240V~ 50-60Hz	653.00	721.00	5/100
AA 3 157	9405	LED Signage* customizable, 240V~ 50-60Hz	682.00	749.00	5/100
AA 3 158 WH	9405	Step Marker (LED) - White 240V~ 50-60Hz	653.00	721.00	5/100
AA 3 158 WW	9405	Step Marker (LED) - Warm White 240V~ 50-60Hz	653.00	721.00	5/100
AA 3 158 BL	9405	Step Marker (LED) - Blue 240V~ 50-60Hz	653.00	721.00	5/100
AA 3 161	9405	Edge Glow LED Signage** 240V~ 50-60Hz	571.00	635.00	5/100
AA 3 161 MA	8538	Edge Glow Square Slide customizable symbol	234.00	-	5/100
AA 3 161 MB	8538	Edge Glow Rectangle Slide customizable symbol	258.00	-	5/100
*Refer Page 65 for customised slide symbols **Edge Glow Slide Supplied separately and can also be customised					



AA 2 073

AA 3 072



AA 1 053

AA 2 054

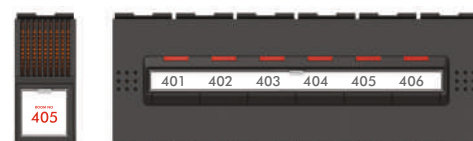

AA 1 050

AA 6 155



AA 2 074

AA 2 108

AA 3 075 GA

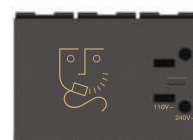

AA 3 076



AA 3 156

AA 3 157



AA 3 158-WH

AA 3 158-WW



AA 3 158-BL



AA 3 161 MA



AA 3 077

AA 3 078



AA 3 079

AA 3 122

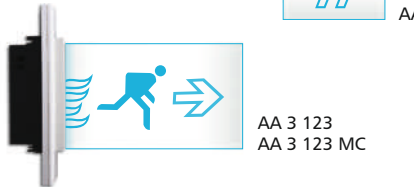
AA 3 123
AA 3 123 MAAA 3 123
AA 3 123 MBAA 3 123
AA 3 123 MC

AA 3 151-WH

AA 4 149-WH

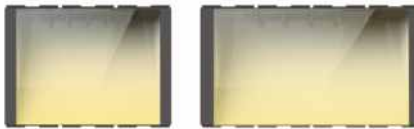

AA 3 151-WW

AA 4 149-WW

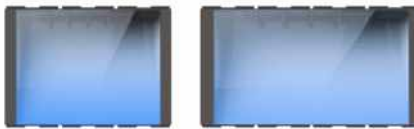

AA 3 151-BL

AA 4 149-BL



AA 4 148-WH

AA 4 148-WW



AA 4 148-BL

CODE	HSN CODE	ITEM	MRP ₹		
			GLOSSY WHITE	ELE. GREY GRAPHITE MAGNESIA STD./ MST. BLACK GOLD PKG.	
SIGNAGES (WITH SUPPORT FRAME & PLATE) 240V~ 50-60Hz - 3MODULE					
AA 3 077	9405	Foot Light (LED) with support frame & plate	684.00	769.00	5/100
AA 3 078	9405	Step Marker (LED) with support frame & plate	635.00	710.00	5/100
AA 3 079	9405	LED Indicator with support frame & plate having two light pads, customizable	710.00	790.00	5/100
AA 3 122	9405	LED Signage* with support frame & plate, customizable	710.00	790.00	5/100
*Refer page 69 for customised slide symbols					
EDGE GLOW LED SIGNAGES					
AA 3 123	9405	Edge Glow LED Signage with support frame & plate, 240V~ 50-60Hz	615.00	678.00	5/100
AA 3 123 MA	8538	Edge Glow Square Slide* (customizable symbol)	254.00	-	10/100
AA 3 123 MB	8538	Edge Glow Rectangle Slide* (customizable symbol)	281.00	-	10/100
AA 3 123 MC	8538	Edge Glow 'L' Type Slide* (customizable symbol)	313.00	-	10/100
*Edge Glow Slide Supplied separately and can also be customised refer Page 69 for customised slides					
FLOOR & STEP LIGHTS 240V~ 50-60Hz - 3 & 4 MODULE					
AA 3 151 WH	9405	Accent Light with LED* - White	682.00	749.00	10/300
AA 3 151 WW	9405	Accent Light with LED* - Warm White	682.00	749.00	10/300
AA 3 151 BL	9405	Accent Light with LED* - Blue	682.00	749.00	10/300
AA 4 149 WH	9405	Accent Light with LED* - White	732.00	807.00	5/150
AA 4 149 WW	9405	Accent Light with LED* - Warm White	732.00	807.00	5/150
AA 4 149 BL	9405	Accent Light with LED* - Blue	732.00	807.00	5/150
*Fully recessed floor & step light					
FLOOR & STEP LIGHT 240V~ 50-60Hz - 4 MODULE					
AA 4 148 WH	9405	Accent Light with LED* - White	790.00	869.00	5/50
AA 4 148 WW	9405	Accent Light with LED* - Warm White	790.00	869.00	5/50
AA 4 148 BL	9405	Accent Light with LED* - Blue	790.00	869.00	5/50
*Fully recessed floor & step light with casaviva support frame & plate					

CODE	HSN CODE	ITEM	MRP ₹		
			GLOSSY WHITE	ELE. GREY GRAPHITE MAGNESIA STD./ MST. BLACK GOLD	PKG.
G-POWER 25A UNITS - 4 MODULE					
AA 4 068	8536	G-Power 25A combined unit with concealed metal box with 4M Wavio Plate + 25A MCB + 25A Socket + 16A Magnus plug top	885.00	981.00	5/30
AA 4 069	8536	G-Power 25A combined unit with slim surface junction box with 4M Wavio Plate + 25A MCB + 25A Socket + 16A Magnus plug top	852.00	937.00	5/30
AA 4 171	8536	G-Power 25A combined unit With Concealed Box with 4M Casaviva Plate + 25A MCB + 25A Socket + 16A Magnus plug top	769.00	859.00	5/30
AA 3 173	8536	G-Power 25A combined unit With Concealed Plastic Junction Box with 3M Casaviva Plate + 25A MCB + 25A Socket + 16A Magnus plug top	625.00	-	0/00
SINGLE POLE MCBs 240V~ 50-60Hz - 1 MODULE					
AA 1 110	8536	C6 SP MCB*	326.00	359.00	10/300
AA 1 111	8536	C10 SP MCB*	326.00	359.00	10/300
AA 1 112	8536	C16 SP MCB*	326.00	359.00	10/300
AA 1 113	8536	C20 SP MCB*	326.00	359.00	10/300
AA 1 114	8536	C25 SP MCB*	326.00	359.00	10/300
AA 1 115	8536	C32 SP MCB*	326.00	359.00	10/300
		*Breaking Capacity 3kA			
DOUBLE POLE MCBs 240V~ 50-60Hz - 2 MODULE					
AA 2 116	8536	C6 DP MCB*	640.00	702.00	10/200
AA 2 117	8536	C10 DP MCB*	640.00	702.00	10/200
AA 2 118	8536	C16 DP MCB*	640.00	702.00	10/200
AA 2 119	8536	C20 DP MCB*	640.00	702.00	10/200
AA 2 120	8536	C25 DP MCB*	640.00	702.00	10/200
AA 2 121	8536	C32 DP MCB*	640.00	702.00	10/200
		*Breaking Capacity 3kA			
MOTOR STARTER SWITCHES (SINGLE PHASE) 240V~ 2 MODULE					
AA 2 138	8536	16Amp Motor Starter Switch	692.00	759.00	10/200
AA 2 139	8536	20Amp Motor Starter Switch	692.00	759.00	10/200
AA 2 140	8536	25Amp Motor Starter Switch	692.00	759.00	10/200
AA 2 141	8536	32Amp Motor Starter Switch	692.00	759.00	10/200



AA 4 068 / AA 4 069



AA 4 171



AA 3 000



AA 1 110 AA 1 111 AA 1 112



AA 1 113 AA 1 114 AA 1 115



AA 2 116 AA 2 117 AA 2 118



AA 2 119 AA 2 120 AA 2 121



AA 2 138 AA 2 139



AA 2 140 AA 2 141

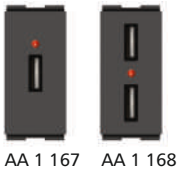

CODE	HSN CODE	ITEM	MRP ₹		
			GLOSSY WHITE	ELE. GREY GRAPHITE MAGNESIA STD. BLACK GOLD	STD./ MST. PKG.
UNIVERSAL USB CHARGERS 240V~ 50-60Hz - 1, 2 & 3 MODULE					
AA 1 167	8504	USB Charger with Indicator (LED) Output - 5V DC, 2.1A	943.00	1049.00	5/100
AA 1 168	8504	USB Charger with Indicator (LED) 2 USB ports, Output-5V DC, 2.1A	1060.00	1170.00	5/100
AA 2 453	8504	USB Charger with Indicator (LED) 2 USB ports, Output - 5V DC, 2.1A	1230.00	1355.00	5/100
AA 3 454	8504	USB Charger & 13Amp International Socket with indicator (LED) - 3M, 2 USB ports, Output - 5V DC, 2.1A	1420.00	1560.00	5/100
AA 2 455	8504	USB Charger with Indicator (LED) Output - 5V DC, 1A	930.00	1000.00	5/100
ENERGY METER / Wi-Fi ROUTER 240V~ 50-60Hz - 2 & 3 MODULE					
AA 2 164	9028	Energy Meter Max load capacity - 3000Watt	3600.00	4200.00	5/50
AA 3 163	8517	Wi-Fi Router + Extender 2300MBPS, Wireless Data Rate: 802.11a/b/g/n, DLNA Media Streaming, 2.4GHz with built in Dual antennas, Universal Repeater.	4558.00	5194.00	1/20
G-HUB - TABLE MOUNTED QI CHARGER WITH HUB					
AA C 428	8504	G-HUB Table Mounted Qi Charger with Hub NEW Technical Specifications 1. Power Input: PD Charger, 45W-65W Output 2. 2 HDMI Inputs, either from Type C or from HDMI port 3. 2 HDMI Outputs, either from upper board or from lower board, supporting 4K, 30fps 4. Micro SD card reader, Max speed 480Mbps 5. 2X USB3.0 transmission, up to 5Gbps, Compatible with USB2.0 6. 1 USB3.0 transmission, up to 5Gbps, not compatible with USB2.0, USB Power Charging up to 5V 2A 7. Type C Power charging up to 5V 2A; 8. Lan Out up to 100M 9. Type C input and output for Laptop, both for data and power Wireless charger: 5W output Tips 1. There is only one output or input for HDMI simultaneously, while direct HDMI input and the upper output is in priority 2. Power charging output is dependent on AC power input, but total output of USB and of wireless charging is 10W 3. Power to charge Laptop should be required by the Laptop, maximum output is 60W 4. Lan port supports 1000M speed, but dependent on original input. 5. We use very high solution to make the prototype, so it is a spec-leading product in performance. 6. It is only a prototype, there must be some flaws, so your advice to improve the product is very important.	-	14999.00	5/50



USB charger & International socket with Wavio Cover Plate

If you want to stay connected, you have to stay charged.

Stay in sync with your home entertainment needs, data transfer or device charging solutions. The innovative USB charging sockets charge devices such as mobile phones or MP3 players directly using the socket outlet without an additional charger.



Ideal for every living room

I-DOCK MUSIC PLAYER

Would you prefer a music player that just plays music or an i-Dock that plays music via Bluetooth, changes track with gestures, has SIRI, lets you take phone calls and also charges your phone?



AA 2 084



AA 2 469



Bluetooth



AA 2 470



Bluetooth



Siri/S-Voice



Gesture Control



AA 4 467



Bluetooth



Siri/S-Voice



Gesture Control



AA 4 468



Android



Bluetooth



S-Voice



Gesture Control

CODE	HSN CODE	ITEM	MRP ₹		
			GLOSSY WHITE	ELE. GREY GRAPHITE MAGNESIA STD./MST. BLACK GOLD	PKG.
FM RADIO 240V~ 50-60Hz - 2 MODULE					
AA 2 084	8527	FM Radio Unit with Speaker with 2 channel memory, sleep mode and auto scan function (frequency 87.50-108MHz)	3990.00	4300.00	5/100
BLUBEAT MUSIC SYSTEM 240V~ 50-60Hz - 2 MODULE					
AA 2 469	8518	BluBeat Bluetooth Music System Audio Output - 2 Speaker out 3W each*, Bluetooth stereo connectivity to any Bluetooth enabled device. LED indication for power & Bluetooth. Can be connected to external ceiling or in-wall speaker through amplifier. (Amplifier not included) *(AA 2 147 Sound Plus speaker not included)	2900.00	3200.00	1/10
BLUPOD MUSIC SYSTEM 240V~ 50-60Hz - 2 MODULE					
AA 2 470	8518	BluPod Bluetooth Music System Capacitive touch controlled, Audio Output - 2 Speaker out 3W each* Bluetooth stereo connectivity to any Bluetooth enabled device. LED indication for power & Bluetooth. Gesture control for music & cell phone communication, SIRI / S-Voice enabled. Can be connected to external ceiling or in-wall speaker through amplifier. (Amplifier not included) *(AA 2 147 Sound Plus speaker not included)	3900.00	4200.00	1/10
i-DOCK MUSIC SYSTEM 240V~ 50-60Hz - 4 MODULE					
AA 4 467	8518	i-Dock Docking & Music System Capacitive touch controlled, charging for i-Phone 5, 5S, 5C, 6, 6S, 7, 7S, 8, 8S, 10, 10S, XR, i-Pod Touch/i-Pad Air, Audio Output - 2 Speaker out 3W each*, Bluetooth stereo connectivity to any Bluetooth enabled device. LED indication for power & Bluetooth. Gesture control for music & cell phone communication, SIRI enabled. Can be connected to external ceiling or in-wall speaker through amplifier. (Amplifier not included) *(AA 2 147 Sound Plus speaker not included)	6900.00	7600.00	1/10
GALAXY MUSIC SYSTEM 240V~ 50-60Hz - 4 MODULE					
AA 4 468	8518	Galaxy Docking & Music System Capacitive touch controlled, Samsung S2 and above compatible with charger, Audio Output - 2 Speaker out 3W each* Bluetooth stereo connectivity to any Bluetooth enabled device. LED indication for power & Bluetooth. Gesture control for music & cell phone communication, S-Voice enabled. Can be connected to external ceiling or in-wall speaker through amplifier. (Amplifier not included) *(AA 2 147 Sound Plus speaker not included)	6900.00	7600.00	1/10

CODE	HSN CODE	ITEM	MRP ₹		
			GLOSSY WHITE	ELE. GREY GRAPHITE MAGNESIA STD./ MST. BLACK GOLD	PKG.
SOUND PLUS STEREPHONIC SPEAKER - 2 MODULE					
AA 2 147	8518	Sound Plus Speaker 2 pcs., Output - 3Watt each	1399.00	1499.00	1/10
BLUETOOTH MUSIC + MOBILE COMMUNICATION SYSTEM 240V~ 50-60HZ - 7 M					
AA 7 457	8518	Bluetooth Player with Inbuilt Stereophonic Speaker & Cell Phone Communication system Bluetooth stereo connectivity to any Bluetooth enabled device. Multi-functional device that plays music. Audio Output - in-built speaker 3W each, stereo line out. Aux mode. Bluetooth handsfree facility & USB charger with indicator (LED) (Amplifier not included)	5900.00	6500.00	5/100
BLUETOOTH MUSIC + MOBILE COMMUNICATION SYSTEM 240V~ 50-60HZ					
AA C 416	8518	SpeeCup Siri / S Voice Enabled Bluetooth Speaker Cell Phone Communication system Bluetooth stereo connectivity to any Bluetooth enabled device. Multi-functional device that plays music, gesture control, voice control, Audio Output - in-built speaker, USB charger with indicator (LED). (Available in 3 Colours White, Red & Black)	11500.00	-	1/8
G-CONNECT BLUETOOTH MUSIC SYSTEMS 240V~ 50-60Hz					
AA C 462	8518	G-Connect Bluetooth Music System with 2.5" Speakers & Remote, Two 2.5" Loudspeaker, IR Receiver/ Transmitter built-in to the loudspeaker Grill, Remote Control with display, 1.5 W + 1.5 W Stereo Output, built-in FM radio with 30 memory presets.	5900.00	-	1/10
AA C 463	8518	G-Connect Bluetooth Music System with 5" Speakers & Remote, Two 5" Loudspeaker, IR Receiver/ Transmitter built-in to the loudspeaker Grill, Remote Control with display, 1.5 W + 1.5 W Stereo Output, built-in FM radio with 30 memory presets.	7900.00	-	1/10



AA 2 147

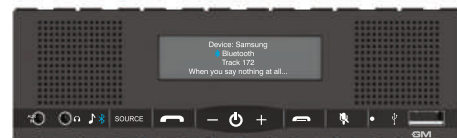

AA 7 457



AA C 416

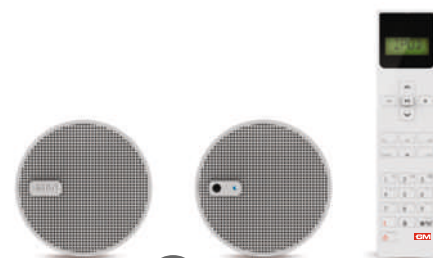

AA C 462

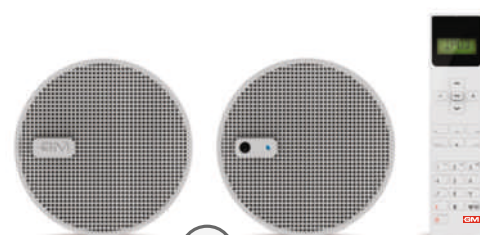

AA C 463



AA C 401
AA C 401 MB

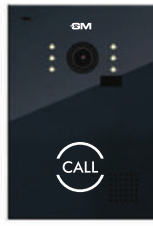

AA C 401



AA C 405



AA C 406



AA C 418



AA C 409



AA C 409 N



AA C 419



AA 2 165



CODE	HSN CODE	ITEM	MRP ₹		
			GLOSSY WHITE	ELE. GREY GRAPHITE MAGNESIA BLACK GOLD	STD./ MST. PKG.
TOUCH VIDEO DOOR ENTRY SYSTEM 240V~ 50-60Hz					
AA C 401	8517	Touch Video Door Entry System with DIN Rail Mountable Power Supply Output 14.5V DC., 2 Way Audio Comm., Compatible to electronic door lock, camera with flash light to outdoor unit	-	15900.00	1/4
AA C 401 MB	8517	Touch Video Indoor Monitor* with DIN Rail Power Supply Output 14.5V DC. *[Maximum 4 indoor monitors can be connected with one outdoor unit]	-	9900.00	1/10
VIDEO DOOR PHONE INDOOR UNITS					
AA C 405	8517	SMART Video Indoor Monitor In-built power supply - 230V AC, 7" colour LCD Hi-Definition, 12 polyphonic ring tones, Automatic image capturing with internal flash, Monitor to monitor calling facility, Real time monitoring from door bell or CCTV camera, Upto 3 CCTV cameras can be connected, Door unlocking facility.	-	11900.00	1/10
AA C 406	8517	AERO Video Indoor Monitor In-built power supply - 230V AC, 7" colour LCD Hi-Definition Touch Screen, Video & Audio recording, Automatic image capturing with internal flash or memory card, Monitor to Monitor calling facility, Call transfer facility (PBX), Multimedia function: Photo frame, Music playing, Real time monitoring from door bell or CCTV camera, Upto 3 CCTV cameras can be connected, Door unlocking facility.	-	19000.00	1/10
AA C 418	8517	ARISTO Video Indoor Monitor Power supply Adaptor 100-240V AC, 4.3" Colour Digital LCD Screen, Video and audio recording, Automatic image capturing with internal flash/ external monitor to monitor calling facility, Multimedia Function: Photo Frame, Music Playing Real time monitoring from doorbell or CCTV, Door unlocking facility.	-	12900.00	1/10
VIDEO DOOR PHONE OUTDOOR UNITS					
AA C 409	8517	SMART Camera Door Bell Outdoor Unit* Hi Cleaner CMOS colour camera, 4 - wire connection, Support lock control, 56° viewing angle, Metal Housing, IR LED for night vision, Water & Vandal proof *Compatible with AA C 405	-	5700.00	1/10
AA C 409 N	8517	SMART Camera Door Bell Outdoor Unit* Hi Cleaner CMOS colour camera, 4 - wire connection, Support lock control, 53° viewing angle, Metal Housing, LED for night vision, Water & Vandal proof *Compatible with AA C 405, AA C 406 & AA C 418	-	5500.00	1/20
AA C 419	8517	ARISTO Camera Door Bell Outdoor Unit* Hi Cleaner CMOS colour camera, 4 - wire connection, Support lock control, 110° viewing angle, Aluminium Housing, DVR function with motion detector, IR LED for night vision, Water & Vandal proof *Compatible with AA C 405, AA C 406 & AA C 418	-	5700.00	1/20
i-CAM VIDEO DOOR ENTRY SYSTEM - 2 MODULE					
AA 2 165	8517	i-CAM Video Door Camera for 4 Wire Connection and Speaker with Bell Push, Support lock control, 100° Viewing angle, Night Vision & Waterproof *Compatible with AA C 405, AA C 406 & AA C 418	6600.00	7500.00	1/50



i-CAM Video door phone with wavio cover plate

The world's smallest video door phone with a technology that induces all-round safety possibilities.

The one thing that protects your world from the outside world is your door. And this entry has to be shielded with the best. Introducing i-CAM Video Door Phone that guards your home with utmost protection. The GM video door phones are a perfect blend of aesthetics and ergonomics. They comprise user-friendly interface, good digital display for providing security to homes, apartments and offices.



Visible beauty. Invisible security.

VIDEO DOOR PHONE

That's the fascinating feature of our security products. They appear so beautiful and quietly keep functioning brilliantly giving you complete peace of mind.

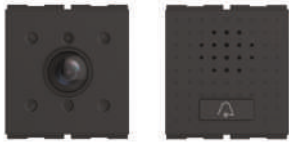

AA 2 169



AA C 415



AA C 420



AA C 421



AA C 422



AA C 423



AA C 410



AA C 411



AA C 413

CODE	HSN CODE	ITEM	MRP ₹		
			GLOSSY WHITE	ELE. GREY GRAPHITE MAGNESIA STD./ BLACK GOLD	MST. PKG.
i-CAM VIDEO DOOR ENTRY SYSTEM - 2 MODULE					
AA 2 169	8517	i-CAM Video Door Camera for TCP/IP Connection and Speaker with Bell Push, Support lock control, 100° Viewing angle, Night Vision & Waterproof *Compatible with AA C 420 & AA C 422	6600.00	7500.00	1/50
WIRELESS VIDEO DOOR ENTRY SYSTEM 110 - 230V~					
AA C 415	8517	WIRELESS Video Door Phone Outdoor unit - 2" C" Size Alkaline Battery or DC Adaptor 12V - 500mA, 2.4" (320x240) QVGA LCD display, Automatic image capturing with internal flash, Real time monitoring, Door unlocking facility, Max. 4 outdoor units can be supported, Transmitting distance: Upto 200m range outside, Wide angle Lens & LED for night vision, IP55 Protection.	-	9900.00	1/10
G-ACCESS VIDEO DOOR ENTRY SYSTEM					
AA C 420	8517	G-Access Indoor Monitor PRO Power Supply: Indoor Unit - Adaptor 15-18V DC. Auto lift monitor, TCP/IP Base, 7" TFT LCD Touch Screen - 800 x 480 p. A/V recording, Music video playing, Door unlock & panic alarm.	-	56000.00	1/10
AA C 421	8517	G-Access Outdoor Camera Power Supply: Indoor Unit - Adaptor 15-18V DC 56° Viewing angle. Night Vision	-	11900.00	1/10
AA C 422	8517	G-Access Indoor Monitor Power Supply: Indoor Unit - Adaptor 15-18V DC. TCP/IP Base, 7" TFT LCD Touch Screen - 800x480 p. A/V recording, Music video playing, Door unlock & panic alarm.	-	24000.00	1/10
AA C 423	8517	G-Access Apartment Camera Power Supply: Indoor Unit - Adaptor 15-18V DC. Support 9999 TCP/IP VDPs, 4" TFT LED Screen, IR Night Vision, Bio-metric Reader, Door access via G-Access App, 5M Pixels Camera, Voice Mail & 720p HD Stream Video	-	75000.00	1/10
APARTMENT VIDEO DOOR ENTRY SYSTEM					
AA C 410	8517	Video Door Bell Outdoor Unit* (For Apartment), Power - 18-36V DC 1/4 CCD Camera, ID/IC card unlock**, 56° Viewing angle, Night Vision & Waterproof, Max. can support 9999 subscribers **ID/IC card not included	-	39900.00	1/10
AA C 411	8517	Horizontal Distributor Unit* Power - 18-36V DC, 1W - 3Watt connection between unit bus & system bus support outdoor unit - 8 Max. support AA C 413 - 99 Communication mode - CAN Bus *Compatible with AA C 405, AA C 406 & AA C 418	-	11200.00	1/50
AA C 413	8517	Vertical Distributor Unit* Power - 18-36V DC, 0.8W - 2Watt with ports for 4 extension monitors (AA C 406 or AA C 405) Video/Audio Signal Transmission Mode - Differential Communication Mode - CAN Bus	-	6900.00	1/50

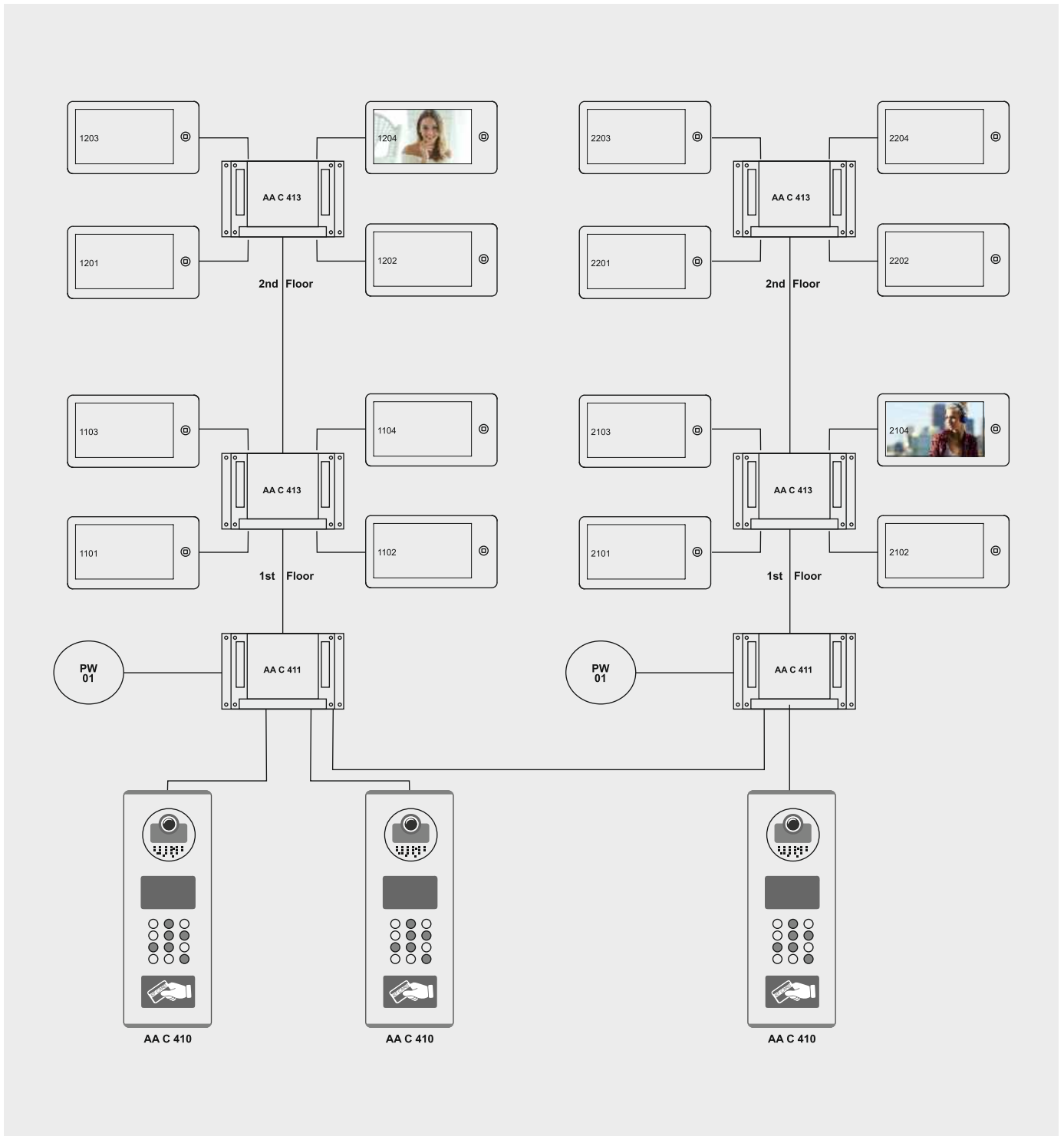

APARTMENT VDP WIRING LAYOUT

SECURITY ISN'T AN OPTION ANY MORE. IT IS A NEED. AND THERE ARE A LOT OF THINGS YOU CAN DO TO TAKE PRECAUTIONS FROM CRIME. THUS IT IS IMPORTANT TO TAKE AN EXTRA STEP TO ENSURE YOUR PROPERTY IS PROTECTED WITH FOOLPROOF SECURITY. THE GM APARTMENT VIDEO DOOR PHONE EXTENDS ITS EXPERTISE TO RESIDENTIAL BUILDINGS BY INTRODUCING THE MULTI-APARTMENT VIDEO DOOR PHONE. THE MODERN AND INNOVATIVE APARTMENT VDP ADVANCED SYSTEM IS MADE TO MEET THE SECURITY NEEDS OF THE HIGH-RISE BUILDINGS. THE APARTMENT VDP HAS DUAL SAFETY PROCEDURE THAT PROVIDES EXCEPTIONAL PROTECTION TO HOMEOWNERS. THE VISITOR HAS TO BYPASS THE BUILDING ENTRANCE FIRST BEFORE HE REACHES THE RESPECTIVE HOUSE. THERE IS ANOTHER ADVANTAGE OF INTER-FLATS COMMUNICATION WITHIN THE BUILDING.



Comfort comes at the touch of your finger

ADORE TOUCH SWITCH

We can't tell you how much we like you to be comfortable. Which is why we made the Touch switch that operates just at a touch of a button. Now all you have to do is decide where you want to relax.



CODE	HSN CODE	ITEM	MRP ₹		
			GLOSSY WHITE	ELE. GREY GRAPHITE MAGNESIA STD./ BLACK GOLD	MST./ PKG.
TOUCH SWITCHES (with integral relay) 110 - 240V~					
AA 1 201	8536	Touch - 1 Switch - 1M 6A	660.00	725.00	5/100
AA 2 203	8536	Touch - 2 Switch with Master - 2M 6A each	1200.00	1320.00	5/100
AA 2 204	8536	Touch - 3 Switch with Master - 2M 6A each	1725.00	1895.00	5/100
AA 3 207	8536	Touch - 4 Switch with Master - 3M 6A each	2200.00	2420.00	5/100
AA 3 208	8536	Touch - 5 Switch with Master - 3M 6A each	2550.00	2805.00	5/100
AA 2 211	8536	Touch - 16Amp Switch - 2M	990.00	1090.00	5/100
AA 1 215	8536	Touch - 2 Way Switch - 1M	1035.00	1135.00	5/100
TOUCH DIMMERS & SWITCH COMBINATIONS 110 - 240V~					
AA 1 202	8533	Touch - Dimmer - 1M 450Watt	780.00	855.00	5/100
AA 2 206	8533	Touch - 1 Dimmer with Master - 2M - 450Watt	830.00	910.00	5/100
AA 3 210	8533	Touch - 2 Dimmer with Master - 3M - 450Watt each	1500.00	1650.00	5/100
AA 2 205	8533	Touch - 1 Dimmer & 1 Switch with Master - 2M Dimmer 450Watt, Switch - 6A	1360.00	1495.00	5/100
AA 3 209	8533	Touch - 1 Dimmer & 2 Switch with Master - 3M Dimmer 450Watt, Switch - 6A each	1900.00	2090.00	5/100
AA 2 213	8533	Touch - Dimmer with 9 Steps Digital Display & Master - 2M - 450Watt	1020.00	1120.00	5/100
TOUCH STEP FAN REGULATOR 110 - 240V~ 2 MODULE					
AA 2 214	8414	Touch - 4 Step Fan Regulator with Digital Display & Master 100Watt	1850.00	2035.00	5/100

CODE	HSN CODE	ITEM	MRP ₹		
			GLOSSY WHITE	ELE. GREY GRAPHITE MAGNESIA STD./ MST. BLACK GOLD	PKG.
TOUCH INFRARED SWITCHES (with integral relay) 110 - 240V~					
AA 1 251	8536	Touch - Infrared 1 Switch 6A - 1M	870.00	955.00	5/100
AA 2 253	8536	Touch - Infrared 2 Switch - with Master, 6A each - 2M	1360.00	1495.00	5/100
AA 3 257	8536	Touch - Infrared 4 Switch - with Master, 6A each - 3M	2350.00	2585.00	5/100
AA 2 261	8536	Touch - Infrared 20Amp Switch - 2M can be also operated by remote controller - AA R 001	1090.00	1130.00	5/100
TOUCH INFRARED DIMMERS & SWITCH COMBINATIONS 110 - 240V~					
AA 1 252	8533	Touch - Infrared 1 Dimmer 450Watt - 1M	960.00	1055.00	5/100
AA 2 254	8533	Touch - Infrared 1 Dimmer with Master, 450Watt - 2M	980.00	1075.00	5/100
AA 3 259	8533	Touch - Infrared 2 Dimmer - 3M with Master, Dimmer 450Watt each	1660.00	1825.00	5/100
AA 3 258	8533	Touch - Infrared 1 Dimmer & 2 Switch with Master, Dimmer - 3M 450Watt, Switch 6A each	2050.00	2255.00	5/100
AA 2 255	8533	Touch - Infrared Dimmer - with 9 Steps Digital Display - 2M 450Watt can be also operated by remote controller - AA R 001	1190.00	1310.00	5/100
TOUCH INFRARED STEP FAN REGULATOR 110 - 240V~ 2 MODULE					
AA 2 263	8414	Touch - Infrared 4 Step Fan Regulator with Digital Display, 100Watt can be also operated by remote controller - AA R 001	1990.00	2190.00	5/100
TOUCH INFRARED DRAPE / BLIND CONTROLLER 110 - 240V~					
AA 2 256	8536	Touch - Infrared Drape / Blind Controller (1 Curtain), 6A - 2M	1580.00	1740.00	5/100
AA 3 260	8536	Touch - Infrared Drape / Blind Controller (2 Curtains), 6A each - 3M can be also operated by remote controller - AA R 001	2480.00	2730.00	5/100
TOUCH INFRARED REMOTE					
AA R 001	8536	Touch - Infrared Remote Control 2x10 channels, 2 nos. AAA 1.5V Battery (Battery not included) WIRE FREE CONVENIENCE The infrared remote controller allows the user to control the appliances like lights, fans, blinds/drapes through the nominated key. When the key on the remote is pressed, it transmits a signal to the receiver (switch panel) through an infrared beam which in-turn regulates application connected to it.	-	1200.00	1/300



AA 1 251

AA 2 253

AA 3 257



AA 2 261



AA 1 252

AA 2 254

AA 3 259



AA 3 258

AA 2 255



AA 2 263



AA 2 256



AA 3 260



AA R 001

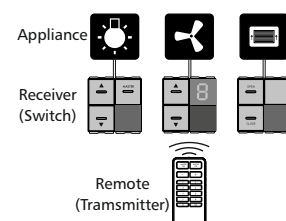

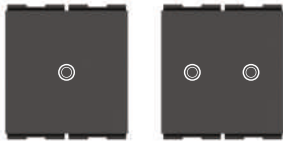

AA 2 501 AA 2 504



AA 2 502 AA 2 503



AA 2 506



AA 2 505

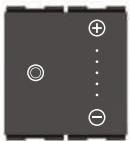

AA 2 507



AA 2 510



AA 2 508 AA 2 509

CODE	HSN CODE	ITEM	MRP ₹		
			GLOSSY WHITE	ELE. GREY GRAPHITE MAGNESIA STD. BLACK GOLD	/ MST. PKG.
ADORE SWITCHES / BELL PUSH 110 - 240V~ 2 MODULE					
AA 2 501	8536	Adore - 1 Switch - 6A 6A Relay output, CFL - 200W Max.	-	2900.00	5/150
AA 2 504	8536	Adore - 2 Switch - 6A each 6A Relay output, CFL - 200W Max. (each switch)	-	3400.00	5/150
AA 2 502	8536	Adore - 2 Way Switch - 6A 6A Relay output, CFL - 200W Max.	-	2900.00	5/150
AA 2 503	8536	Adore - Bell Push Switch 6A Relay output	-	2900.00	5/150
ADORE WAVE SWITCH 110 - 240V~ 2 MODULE					
AA 2 506	8536	Adore - Wave Switch - 6A Electronic Sensor Switch 6A Relay output, Allows to control lights by simply passing the hand in front of it.	-	4280.00	5/150
ADORE 20A SWITCH 110 - 240V~ 2 MODULE					
AA 2 505	8536	Adore - 20A Switch 20A Relay output	-	3400.00	5/150
ADORE LIGHT DIMMER 110 - 240V~ 2 MODULE					
AA 2 507	8533	Adore - Light Dimmer Triac Technology with soft end & soft start function operating load - 300-450Watt Not suitable for FAN	-	3300.00	5/150
ADORE DRAPE / CURTAIN CONTROLLER 110 - 240V~ 2 MODULE					
AA 2 510	8536	Adore - Drape / Curtain controller 6A Relay output	-	3700.00	5/150
ADORE FAN REGULATORS 110 - 240V~ 2 MODULE					
AA 2 508	8414	Adore - 4 Step Fan Regulator 6A Relay output with 4 steps fan coil speed operating load (FAN) - 100W	-	3400.00	5/150
AA 2 509	8414	Adore - 5 Step Fan Regulator 6A Relay output with 5 steps fan coil speed operating load (FAN) - 100W	-	3600.00	5/150

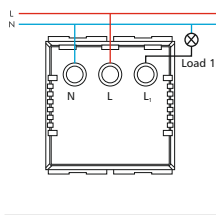
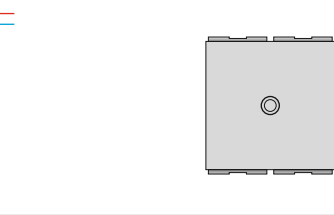
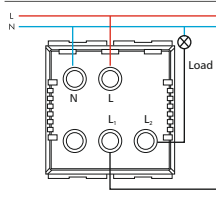
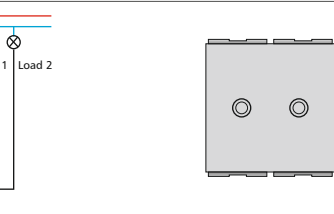
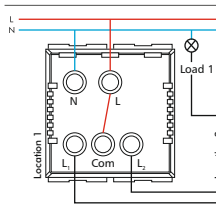
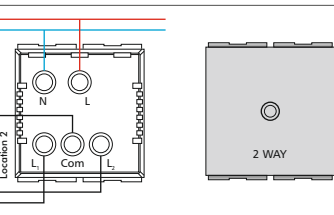
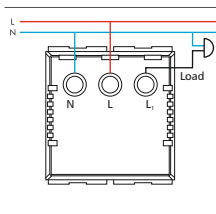
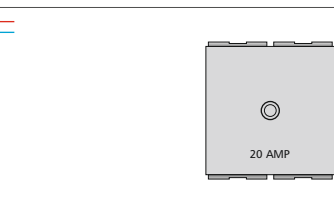
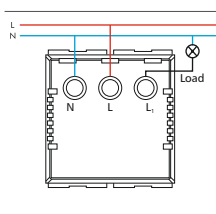
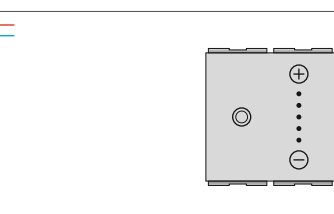
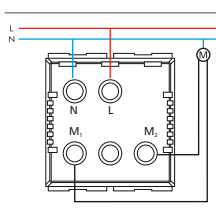
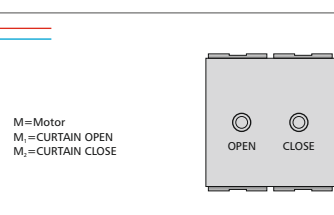
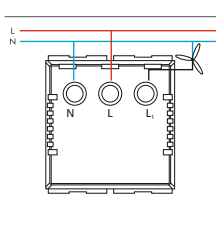
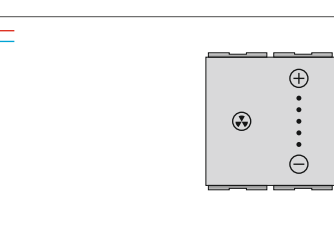
		<p>1 Switch - 6A</p> <ul style="list-style-type: none"> Rated Voltage - 110-240V~ Rated Load <ul style="list-style-type: none"> a) Resistive 6A. b) Incandescent Lamp - 1000W. c) Halogen with Transformer - 700W. d) Halogen without Transformer - 1000W. e) Compact Fluorescent Lamp - 200W. f) Inductive Motor Load (power factor 0.6 lag) 4A.
		<p>2 Switch - 6A Each Switch</p> <ul style="list-style-type: none"> Rated Voltage - 110-240V~ Rated Load - Each Switch <ul style="list-style-type: none"> a) Resistive 6A. b) Incandescent Lamp - 1000W. c) Halogen with Transformer - 700W. d) Halogen without Transformer - 1000W. e) Compact Fluorescent Lamp - 200W. f) Inductive Motor Load (power factor 0.6 lag) 4A.
		<p>2 Way Switch - 6A</p> <ul style="list-style-type: none"> Rated Voltage - 110-240V~ Rated Load - Each Switch <ul style="list-style-type: none"> a) Resistive 6A. b) Incandescent Lamp - 1000W. c) Halogen with Transformer - 700W. d) Halogen without Transformer - 1000W. e) Compact Fluorescent Lamp - 200W. f) Inductive Motor Load (power factor 0.6 lag) 4A.
		<p>20A Switch</p> <ul style="list-style-type: none"> Rated Voltage - 110-240V~ Rated Load - Each Switch <ul style="list-style-type: none"> a) Resistive 20A. b) Incandescent Lamp - 3000W. c) Halogen with Transformer - 2000W. d) Halogen without Transformer - 3000W. e) Compact Fluorescent Lamp - 600W. f) Inductive Motor Load (power factor 0.6 lag) 6A.
		<p>Light Dimmer</p> <ul style="list-style-type: none"> Rated Voltage - 110-240V~ Rated Load - 450W. Tested for 20,000 Switching Cycles at Rated Voltage and Rated Load
		<p>Drap Controller</p> <ul style="list-style-type: none"> Rated Voltage - 110-240V~ Rated Load - 100W. Tested for 20,000 Switching Cycles at Rated Voltage and Rated Load
		<p>5 Step Fan Regulator</p> <ul style="list-style-type: none"> Rated Voltage - 110-240V~ Rated Load - 100W. Tested for 20,000 Switching Cycles at Rated Voltage and Rated Load



Relax. that is all we want to say

I-TOUCH SWITCHES

You don't have to decide between design and comfort! The new Wi-Fi switches offer you both. Ergonomically correct and technologically innovative switches that function only to bring you ease.

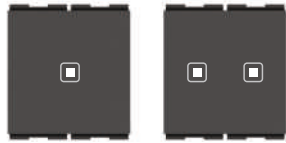

AA 2 520

AA 2 523

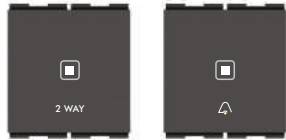

AA 2 521

AA 2 522

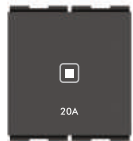

AA 2 524



AA 2 525

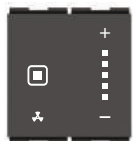

AA 2 526



AA 2 527



AA 2 530



AA G 529



AA E 531



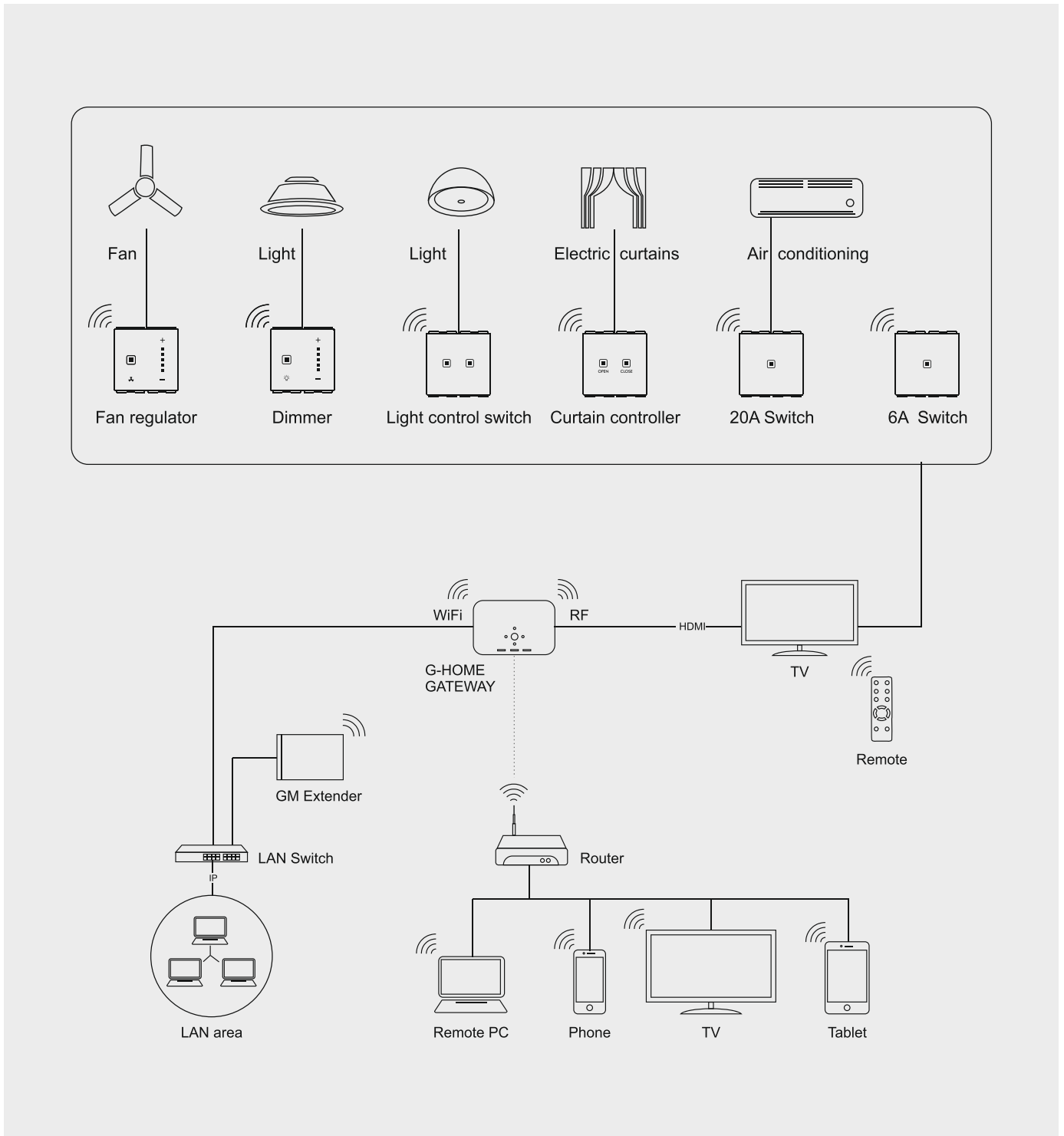







CODE	HSN CODE	ITEM	MRP ₹		
			GLOSSY WHITE	ELE. GREY GRAPHITE MAGNESIA STD./MST. BLACK GOLD PKG.	
i-Fi 6A SWITCHES / BELL PUSH 110 - 240V~ 50-60Hz - 2 MODULE					
AA 2 520	8536	i-Fi - 1 Switch - 6A* 6A relay output, CFL - 200Watt, 1000Watt Max	4000.00	4500.00	1/50
AA 2 523	8536	i-Fi - 2 Switch - 6A each* 6A relay output, CFL - 200Watt, 1000Watt Max (each switch)	4500.00	5000.00	1/50
AA 2 521	8536	i-Fi - 2 Way Switch - 6A* Controls AA 2 520, AA 2 523, AA 2 524 & AA 2 526	4200.00	4700.00	1/50
AA 2 522	8536	i-Fi - Bell Push Switch - 6A *can be also operated with Wi-Fi / 3G or by TV, need to connect i-Fi Gateway [AA G 529]	3000.00	3300.00	1/50
i-Fi 20A SWITCH - 2 MODULE 110 - 240V~ 50-60Hz - 2 MODULE					
AA 2 524	8536	i-Fi - 20A Switch* 20A relay output, Air conditioner - 2 Ton *can be also operated with Wi-Fi / 3G or by TV, need to connect i-Fi Gateway [AA G 529]	4700.00	5300.00	1/50
i-Fi LIGHT DIMMER / FAN REGULATOR 110 - 240V~ 50-60Hz - 2 MODULE					
AA 2 525	8533	i-Fi - Light Dimmer* 500Watt, Triac Technology (Not suitable for FAN)	4500.00	5000.00	1/50
AA 2 526	8414	i-Fi - 5 Step Fan Regulator* 100Watt, 6A relay output with 5 step fan coil speed, operating load (Fan) *can be also operated with Wi-Fi / 3G or by TV, need to connect i-Fi Gateway [AA G 529]	4500.00	5000.00	1/50
i-Fi DRAPE CONTROLLER 110 - 240V~ 50-60Hz - 2 MODULE					
AA 2 527	8536	i-Fi - Drape Controller* 3A relay output *can be also operated with Wi-Fi / 3G or by TV, need to connect i-Fi Gateway [AA G 529]	4600.00	5100.00	1/50
i-Fi DOOR UNLOCK CONTROLLER 110 - 240V~ 50-60Hz - 2 MODULE					
AA 2 530	8536	i-Fi - Door Unlock Controller* 110 - 240V~ 50-60Hz, 3A relay output *can be also operated with Wi-Fi / 3G or by TV, need to connect i-Fi Gateway [AA G 529]	3000.00	3300.00	1/50
i-Fi GATEWAY / EXTENDER					
AA G 529	8536	i-Fi - Gateway with Air Remote 110 - 240V~ 50-60Hz Operating System - Android, CPU : ARM Cortex 48, Power Input - DC 9 - 13V	-	15999.00	1/10
AA E 531	8517	i-Fi - Extender Input DC 5V - 13V, Power ←1W, Maximum 4 Host Control Machine can be connected GM- i-Fi application available on i-OS & Android	6699.00	-	1/50



INTELLIGENT SYSTEM SOLUTIONS

GM I-FI AUTOMATION TECHNOLOGY EXTENDS SMART HOME SOLUTIONS FOR AN INTELLIGENT LIFESTYLE. WITH A ROUTER AND WIRELESS CONNECTION YOU CAN CONTROL YOUR HOME ELECTRICAL DEVICES LIKE TELEVISION, AIR CONDITIONING, LIGHTS, KITCHEN APPLIANCES, CURTAINS, SECURITY-SENSING DEVICES, SECURITY ALARM SYSTEMS ETC.

WHEN YOU ARE AWAY FROM HOME/ OFFICE, ALL YOU NEED IS A CELL PHONE OR A COMPUTER AND ANY INTERNET MEDIUM THAT COMMUNICATES TO YOUR HOME NETWORK THAT FURTHERS CONTROLS THE DEVICES. YOU CAN CONTROL THE REAL-TIME SITUATION AT HOME, EXPERIENCING THE WONDERS OF TECHNOLOGY AT ITS BEST.

- 
Security Alarm
- 
Smart Home
- 
Remote Intelligence
- 
Entertainment
- 
WiFi
- 
Touch
- 
Scene
- 
World
- 
Timer
- 
Retrofitting



AA 2 540

AA 2 543



AA 2 541

AA 2 542



AA 2 544



AA 2 545



AA 2 546



AA 2 547



AA 2 550



AA 2 548

AA 2 549

CODE	HSN CODE	ITEM	MRP ₹		
			GLOSSY WHITE	ELE. GREY GRAPHITE MAGNESIA STD. / MST. BLACK GOLD PKG.	
i-TOUCH Wi-Fi 6A SWITCHES 110 - 240V~ 50-60Hz - 2 MODULE					
AA 2 540	8536	i-Touch Wi-Fi 1 Switch* 6A relay output, 1000Watt Max, CFL - 200Watt Max	3800.00	4200.00	1/50
AA 2 543	8536	i-Touch Wi-Fi 2 Switch* 6A relay output, CFL - 200W Max, 1000Watt Max (each switch)	4200.00	4600.00	1/50
AA 2 541	8536	i-Touch Wi-Fi 2 Way Switch* Can control AA 2 540, AA 2 543, AA 2 544, AA 2 545 & AA 2 546	4000.00	4400.00	1/50
AA 2 542	8536	i-Touch Wi-Fi Bell Push Switch* 6A relay output * can be also operated with Wi-Fi / 3G or by TV, need to connect i-Fi Gateway (AA G 529)	2900.00	3200.00	1/50
i-TOUCH Wi-Fi 20A SWITCH 110 - 240V~ 50-60Hz - 2 MODULE					
AA 2 544	8536	i-Touch 20A Switch* 20A relay output, Air conditioner/ 2 Ton * can be also operated with Wi-Fi / 3G or by TV, need to connect i-Fi Gateway (AA G 529)	4300.00	4800.00	1/50
i-TOUCH Wi-Fi LIGHT DIMMER / FAN REG. 110 - 240V~ 50-60Hz - 2 MODULE					
AA 2 545	8533	i-Touch Wi-Fi Light Dimmer* 500Watt, Triac technology (Not suitable for FAN)	4200.00	4600.00	1/50
AA 2 546	8414	i-Touch Wi-Fi 5 Step Fan Regulator* 100Watt, 6A Rrelay, output with 5 step fan coil speed, operating load (Fan) * can be also operated with Wi-Fi / 3G or by TV, need to connect i-Fi Gateway (AA G 529)	4200.00	4600.00	1/50
i-TOUCH Wi-Fi DRAPE CONTROLLER 110 - 240V~ 50-60Hz - 2 MODULE					
AA 2 547	8536	i-Touch Wi-Fi Drape Controller* 3A relay output * can be also operated with Wi-Fi / 3G or by TV, need to connect i-Fi Gateway (AA G 529)	4400.00	4700.00	1/50
i-TOUCH Wi-Fi DOOR UNLOCK CONTROLLER 110 - 240V~ 50-60Hz - 2 MODULE					
AA 2 550	8536	i-Touch Wi-Fi Door Unlock Controller* 3A relay output * can be also operated with Wi-Fi / 3G or by TV, need to connect i-Fi Gateway (AA G 529)	2900.00	3300.00	1/50
i-TOUCH Wi-Fi DO NOT DISTURB / MAKE MY ROOM 110 - 240V~ 50-60Hz - 2 M					
AA 2 548	8536	i-Touch Wi-Fi DND/Make My Room/ PLEASE WAIT (Inside Room)*, 3A relay output	2400.00	2800.00	1/50
AA 2 549	8536	i-Touch Wi-Fi DND/Make My Room/ Please Wait With Bell Push Switch (Outside Room)*, 3A relay output (Inside & outside unit are connected with each other) * can be also operated with Wi-Fi / 3G or by TV, need to connect i-Fi Gateway (AA G 529) GM- i-Fi application available on i-OS & Android	2600.00	3000.00	1/50

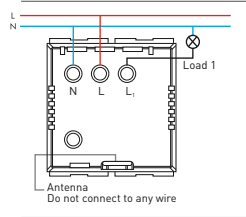
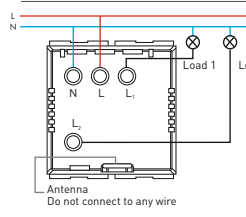
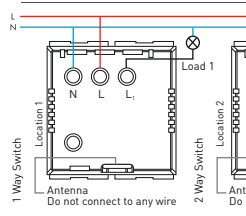
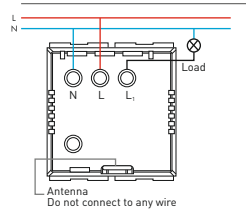
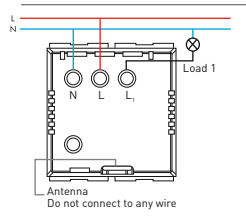
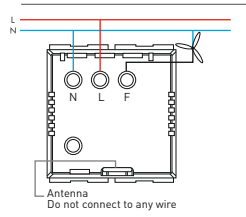
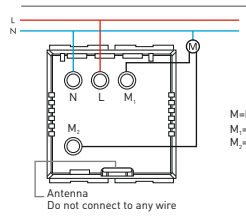
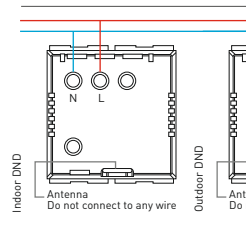
	<p>1 Switch - 6A</p> <ul style="list-style-type: none"> Rated Voltage - 110-240V~ Rated Load <ol style="list-style-type: none"> Resistive 6A. Incandescent Lamp - 1000W. Halogen with Transformer - 700W. Halogen without Transformer - 1000W. Compact Fluorescent Lamp - 200W. Inductive Motor Load (power factor 0.6 lag) 4A.
	<p>2 Switch - 6A Each Switch</p> <ul style="list-style-type: none"> Rated Voltage - 110-240V~ Rated Load - Each Switch <ol style="list-style-type: none"> Resistive 6A. Incandescent Lamp - 1000W. Halogen with Transformer - 700W. Halogen without Transformer - 1000W. Compact Fluorescent Lamp - 200W. Inductive Motor Load (power factor 0.6 lag) 4A.
	<p>2 Way Switch - 6A</p> <ul style="list-style-type: none"> Rated Voltage - 110-240V~ Can control AA 2 520, AA 2 523, AA 2 524, AA 2 526, AA 2 540, AA 2 543, AA 2 544, AA 2 545 & AA 2 546
	<p>20A Switch</p> <ul style="list-style-type: none"> Rated Voltage - 110-240V~ Rated Load - Each Switch <ol style="list-style-type: none"> Resistive 20A. Incandescent Lamp - 3000W. Halogen with Transformer - 2000W. Halogen without Transformer - 3000W. Compact Fluorescent Lamp - 600W. Inductive Motor Load (power factor 0.6 lag) 6A.
	<p>Light Dimmer</p> <ul style="list-style-type: none"> Rated Voltage - 110-240V~ Rated Load - 450W. Tested for 20,000 Switching Cycles at Rated Voltage and Rated Load
	<p>5 Step Fan Regulator</p> <ul style="list-style-type: none"> Rated Voltage - 110-240V~ Rated Load - 100W. Tested for 20,000 Switching Cycles at Rated Voltage and Rated Load
	<p>Drape Controller</p> <ul style="list-style-type: none"> Rated Voltage - 110-240V~ 50Hz. Rated Current - 3A. Inductive Motor Load (power factor 0.6 lag) 3A Tested for 20,000 Switching Cycles at Rated Voltage and Rated Load Low Internal Power Loss Giving Rise to Minimum Temperature Rise
	<p>Do Not Disturb / Make My Room</p> <ul style="list-style-type: none"> Rated Voltage - 110-240V~ 50Hz

Wire colour codes: ■ Red (Live) ■ Blue (Neutral) ■ Black (Load)





AA 2 561

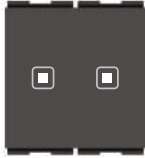

AA 2 563



AA 2 564

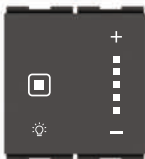

AA 2 565

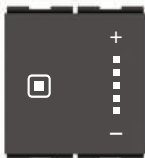

AA 2 566



AA 2 567



AA 2 569



AA E 559

CODE	HSN CODE	ITEM	MRP ₹		
			GLOSSY WHITE	ELE. GREY GRAPHITE MAGNESIA STD. / MST. BLACK GOLD PKG.	
i-Fi PRO 2 WAY SWITCH/SCENE CONTROL 110 - 240V~ 50-60Hz - 2 MODULE					
AA 2 561	8536	i-Fi Pro - 2 Way Switch* Controls AA 2 563, AA 2 564, AA 2 565, AA 2 566, AA 2 569 Can be use as Scene Controller / 2 Way Switch	5200.00	5700.00	1/50
i-Fi PRO 2 SWITCH 110 - 240V~ 50-60Hz - 2 MODULE					
AA 2 563	8536	i-Fi Pro - 2 Switch - 6A each* 6A relay output, CFL - 200Watt, LED COB - 150Watt	5500.00	6000.00	1/50
i-Fi PRO 20A SWITCH 110 - 240V~ 50-60Hz - 2 MODULE					
AA 2 564	8536	i-Fi Pro - 20A Switch* 20A relay output, Air conditioner - 1.5 Ton	5700.00	6300.00	1/50
i-Fi PRO LIGHT DIMMER 110 - 240V~ 50-60Hz - 2 MODULE					
AA 2 565	8533	i-Fi Pro - Light Dimmer* LED COB - 150Watt, Triac Based Dimming (Not suitable for FAN)	5500.00	6000.00	1/50
i-Fi PRO FAN REGULATOR 110 - 240V~ 50-60Hz - 2 MODULE					
AA 2 566	8414	i-Fi Pro - 5 Step Fan Regulator* 100Watt, Capacitive relay based speed control with 5 step operation	5500.00	6000.00	1/50
i-Fi PRO DRAPE CONTROLLER 110 - 240V~ 50-60Hz - 2 MODULE					
AA 2 567	8536	i-Fi Pro - Drape Controller* Inductive Motor Load: 3A/ Channel Only AC Curtain Motors of 4 Wires (UP, DOWN, Neutral & Earthing) can be connected	5600.00	6100.00	1/50
i-Fi PRO DOOR UNLOCK CONTROLLER 110 - 240V~ 50-60Hz - 2 MODULE					
AA 2 569	8536	i-Fi Pro - Door Unlock Controller* 3A relay output, Dry contact relay (Normally Open)	5000.00	5500.00	1/50
i-Fi PRO IR EMITTER 110 - 240V~ 50-60Hz					
AA E 559	8536	i-Fi Pro - IR Emitter* Input: 5V DC, Adapter Included 1A Micro USB Connector 360° IR full range IR launch Upto 10 Meter IR Signal Transmit IR Code Learning Function	-	5200.00	1/10

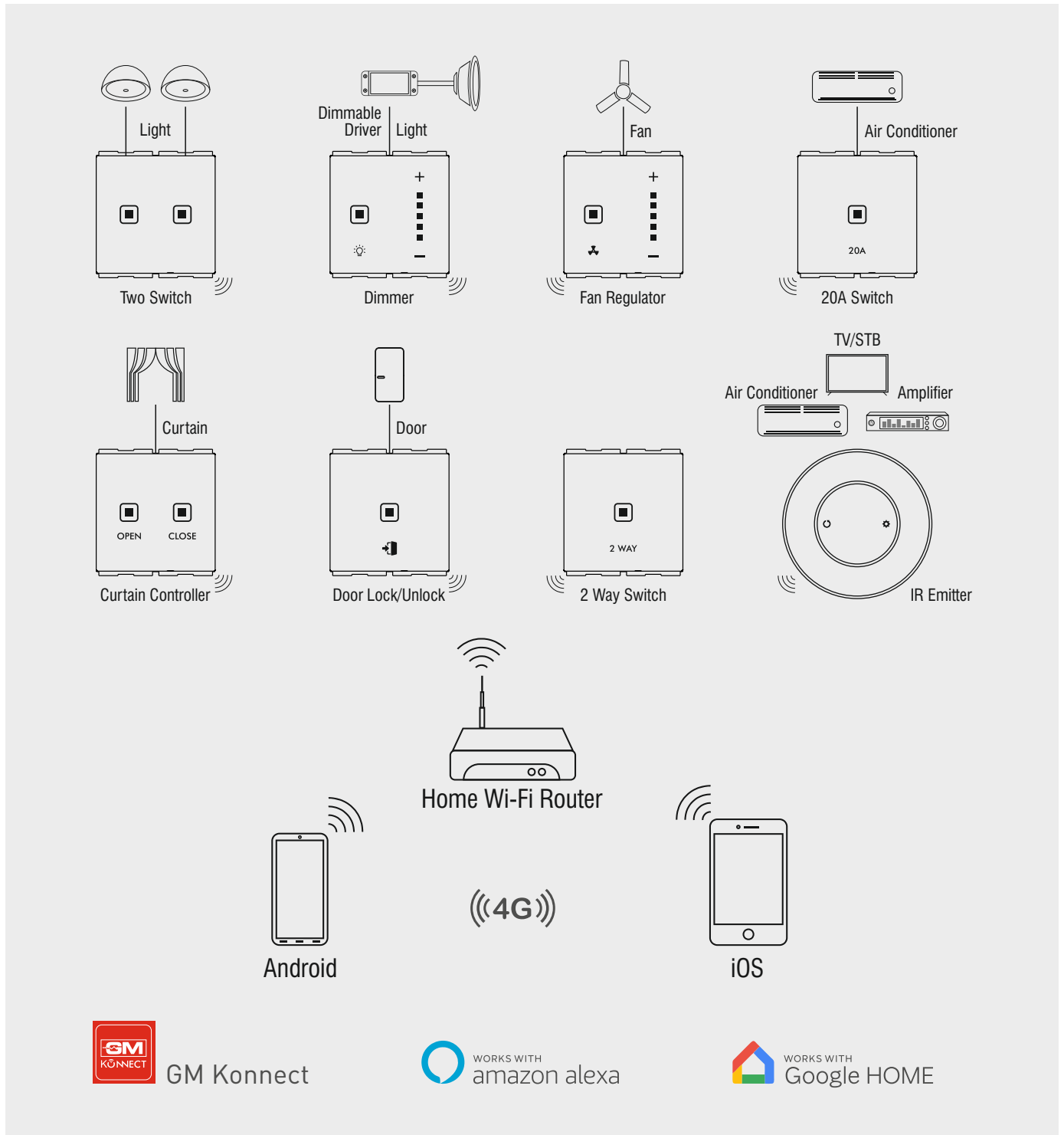

GM Konnect



WORKS WITH amazon alexa



WORKS WITH Google HOME

LIVING THE INTELLIGENT LIFE

GM I-FI PRO AUTOMATION TECHNOLOGY EXTENDS SMART HOME SOLUTIONS FOR AN INTELLIGENT LIFESTYLE. WITH A ROUTER AND WIRELESS CONNECTION YOU CAN CONTROL YOUR HOME ELECTRICAL DEVICES LIKE TELEVISION, AIR CONDITIONING, LIGHTS, CURTAINS, ELECTRONIC DOOR LOCK ETC.

WHEN YOU ARE AWAY FROM HOME/ OFFICE, ALL YOU NEED IS A CELL PHONE AND ANY INTERNET MEDIUM THAT COMMUNICATES TO YOUR HOME NETWORK THAT FURTHERS CONTROLS THE DEVICES. YOU CAN CONTROL THE REAL-TIME SITUATION AT HOME, EXPERIENCING THE WONDERS OF TECHNOLOGY AT ITS BEST.

- Retrofitting
- Entertainment
- Scene
- Curtain
- Air Conditioners
- Touch
- Time Control
- Cloud Based Control



A fantasy fair is your ultimate reality

DISNEY SWITCH PLATE

Your memories can now last forever. By adding a marvelous magical touch to your kids' room with the lively Disney characters around, you are simply going to create your own Disney world within your home.



AA 2 090



AA 2 091



AA 2 094



AA 3 095



AA 2 096



AA 2 097



AA 2 098



AA 2 099



AA 2 100



AA 2 101



AA 3 102



AA 3 103

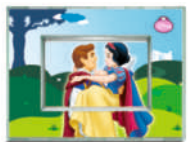

AA 3 104



AA 3 105



AA 3 106



AA 3 107



AA 3 162

CODE	HSN CODE	ITEM	MRP ₹	
			GLOSSY WHITE	STD./MST. PKG.
SNAPZ - 10AX SWITCHES 240V~ 2 & 3 MODULE				
AA 2 090	8536	1 Way Switch without outer display knob, 240V~	90.00	10/100
AA 2 091	8536	Bell Push Switch without outer display knob, 240V~	109.00	10/100
AA 2 094	8536	Snapz Switch outer display knob	24.00	20/100
AA 3 095	8536	Snapz Switch outer display knob	39.00	20/100
DISNEY - 10AX 1 WAY SWITCHES WITH SUPPORT FRAME & PLATE 240V~ 2 MODULE				
AA 2 096	8536	Pooh	396.00	5/100
AA 2 097	8536	Princess	396.00	5/100
AA 2 098	8536	Snow White	396.00	5/100
AA 2 099	8536	Mickey	396.00	5/100
AA 2 100	8536	Hannah Montana	396.00	5/100
AA 2 101	8536	Cars	396.00	5/100
DISNEY - 10AX 1 WAY SWITCHES WITH SUPPORT FRAME & PLATE 240V~ 3 MODULE				
AA 3 102	8536	Pooh	499.00	5/100
AA 3 103	8536	Princess	499.00	5/100
AA 3 104	8536	Snow White	499.00	5/100
AA 3 105	8536	Mickey	499.00	5/100
AA 3 106	8536	Hannah Montana	499.00	5/100
AA 3 107	8536	Cars	499.00	5/100
DISNEY NIGHT LAMP 240V~ 3 MODULE				
AA 3 162	9405	Disney Night Lamp (Available in Pooh, Princess, Snow White, Mickey, Hannah Montana & Cars)	599.00	5/100

Disney Plate with Smart Switches



WE HAVE ALWAYS BELIEVED THAT SOME THINGS ARE JUST PRICELESS. NOT VERY OFTEN WE HAVE PRODUCTS WITH EMOTIONS ATTACHED TO THEM. PERHAPS WITH DISNEY, WE MAKE THE BREAKTHROUGH. AND WE HAVE BUNDLED ALL THESE EMOTIONS INTO SWITCH PLATES AND MADE IT READY TO BE A PART OF YOUR HOME.

Disney Plate with Smart Switches



DISNEY HAS ENTERTAINED US FOR YEARS TOGETHER WITH ITS LIFELIKE CHARACTERS. TIMELESS CHARACTERS LIKE MICKEY MOUSE, DONALD DUCK, CINDERELLA ETC. HAVE ENTERED OUR LIVES ENTERTAINING US ALL THE WAY THROUGH. AND NOW WE HAVE BROUGHT DISNEY EVEN MUCH CLOSER WITH DISNEY SWITCH PLATES.

CASAVIVA - COVER PLATES (with Support Frame)

MODULES	1M	2M	3M	3M*	4M	4M**(H&V)	6M*	6M(3+3)	6M**(H&V)
HSN CODE	8538	8538	8538	8538	8538	8538	8538	8538	8538
PLATES	MRP ₹	MRP ₹	MRP ₹	MRP ₹	MRP ₹	MRP ₹	MRP ₹	MRP ₹	MRP ₹
PURE GLOSSY	CA SF 01 001 106.00	CA SF 02 002 106.00	CA SF 03 003 131.00	CA SF 03 009 131.00	CA SF 04 004 158.00	CA SF 04 017 182.00	CA SF 06 005 213.00	CA SF 06 014 213.00	CA SF 06 018 235.00
GLOSSY	PX SF 01 001 106.00	PX SF 02 002 106.00	PX SF 03 003 131.00	PX SF 03 009 131.00	PX SF 04 004 158.00	PX SF 04 017 182.00	PX SF 06 005 213.00	PX SF 06 014 213.00	PX SF 06 018 235.00
METALIK	PY SF 01 001 146.00	PY SF 02 002 146.00	PY SF 03 003 189.00	PY SF 03 009 189.00	PY SF 04 004 225.00	PY SF 04 017 239.00	PY SF 06 005 287.00	PY SF 06 014 287.00	PY SF 06 018 305.00
WOOD	PJ SF 01 001 195.00	PJ SF 02 002 195.00	PJ SF 03 003 242.00	PJ SF 03 009 242.00	PJ SF 04 004 287.00	PJ SF 04 017 308.00	PJ SF 06 005 384.00	PJ SF 06 014 384.00	PJ SF 06 018 406.00
STD./MST PKG.	20/400	20/400	20/400	20/400	20/400	20/400	10/200	10/200	10/200
SIZE (mm)	93 x 91	93 x 91	123 x 91	118 x 91	151 x 91	155 x 91	219 x 91	219 x 91	222 x 91

CASAVIVA - COVER PLATES (Dimensions in mm)

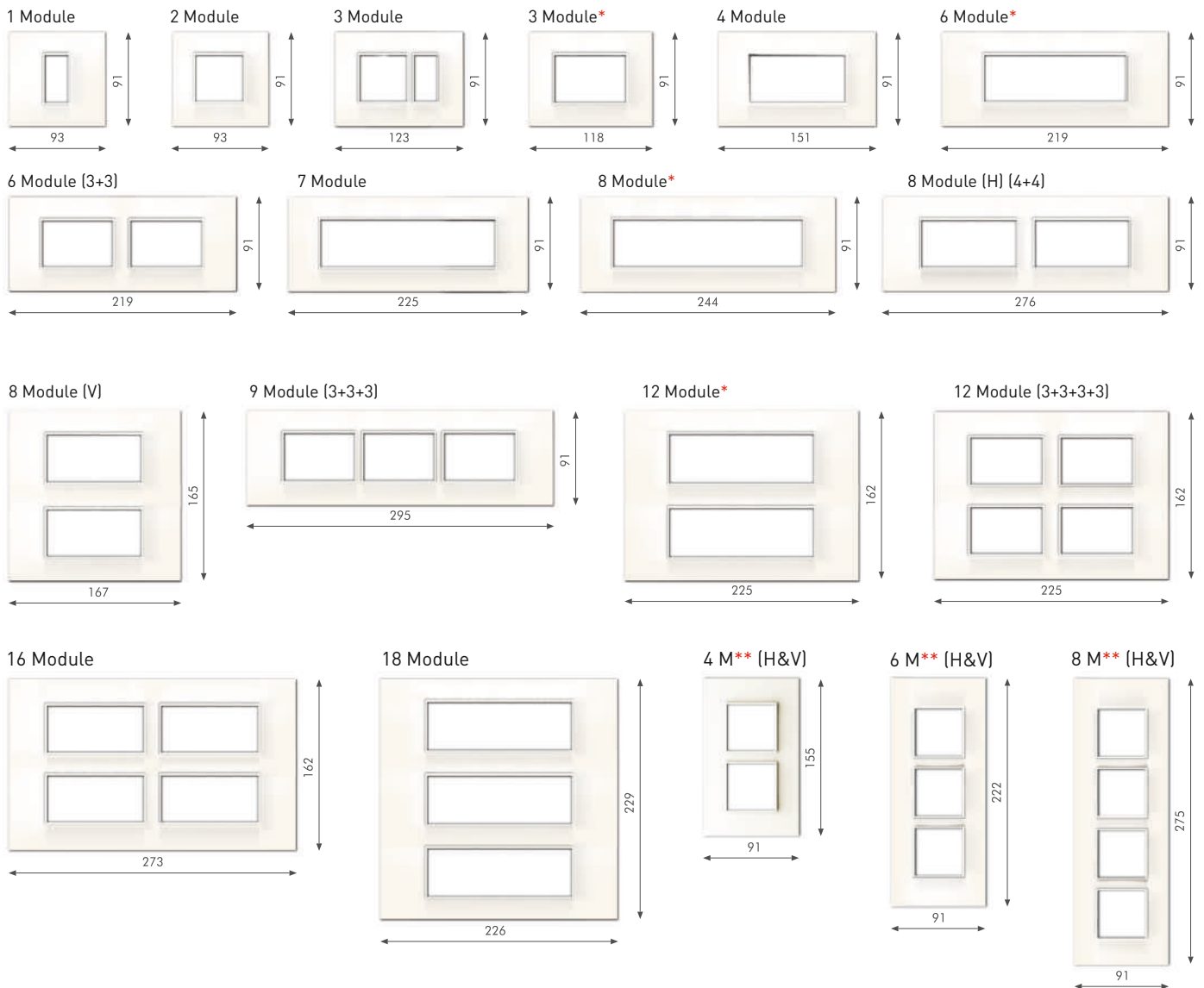

7M	8M*	8M (H)(4+4)	8M** (H&V)	8M (V)	9M (3+3+3)	12M*	12M (3+3+3+3)	16M	18M
8538	8538	8538	8538	8538	8538	8538	8538	8538	8538
MRP ₹	MRP ₹	MRP ₹	MRP ₹	MRP ₹	MRP ₹	MRP ₹	MRP ₹	MRP ₹	MRP ₹
CA SF 07 016 258.00	CA SF 08 006 298.00	CA SF 08 011 272.00	CA SF 08 019 298.00	CA SF 08 012 272.00	CA SF 09 013 311.00	CA SF 12 007 328.00	CA SF 12 015 328.00	CA SF 16 008 354.00	CA SF 18 010 422.00
PX SF 07 016 258.00	PX SF 08 006 298.00	PX SF 08 011 272.00	PX SF 08 019 298.00	PX SF 08 012 272.00	PX SF 09 013 311.00	PX SF 12 007 328.00	PX SF 12 015 328.00	PX SF 16 008 354.00	PX SF 18 010 422.00
PY SF 07 016 348.00	PY SF 08 006 396.00	PY SF 08 011 373.00	PY SF 08 019 396.00	PY SF 08 012 373.00	PY SF 09 013 426.00	PY SF 12 007 469.00	PY SF 12 015 469.00	PY SF 16 008 493.00	PY SF 18 010 514.00
PJ SF 07 016 504.00	PJ SF 08 006 557.00	PJ SF 08 011 523.00	PJ SF 08 019 557.00	PJ SF 08 012 523.00	PJ SF 09 013 576.00	PJ SF 12 007 583.00	PJ SF 12 015 583.00	PJ SF 16 008 670.00	PJ SF 18 010 716.00
10/200	10/200	10/200	10/200	10/200	10/200	10/120	10/120	10/80	10/80
225 x 91	244 x 91	276 x 91	275 x 91	167 x 165	295 x 91	225 x 162	225 x 162	273 x 162	226 x 229

CASAVIVA - SUPPORT FRAMES - Horizontal & Vertical for Fixing (Dimensions in mm)

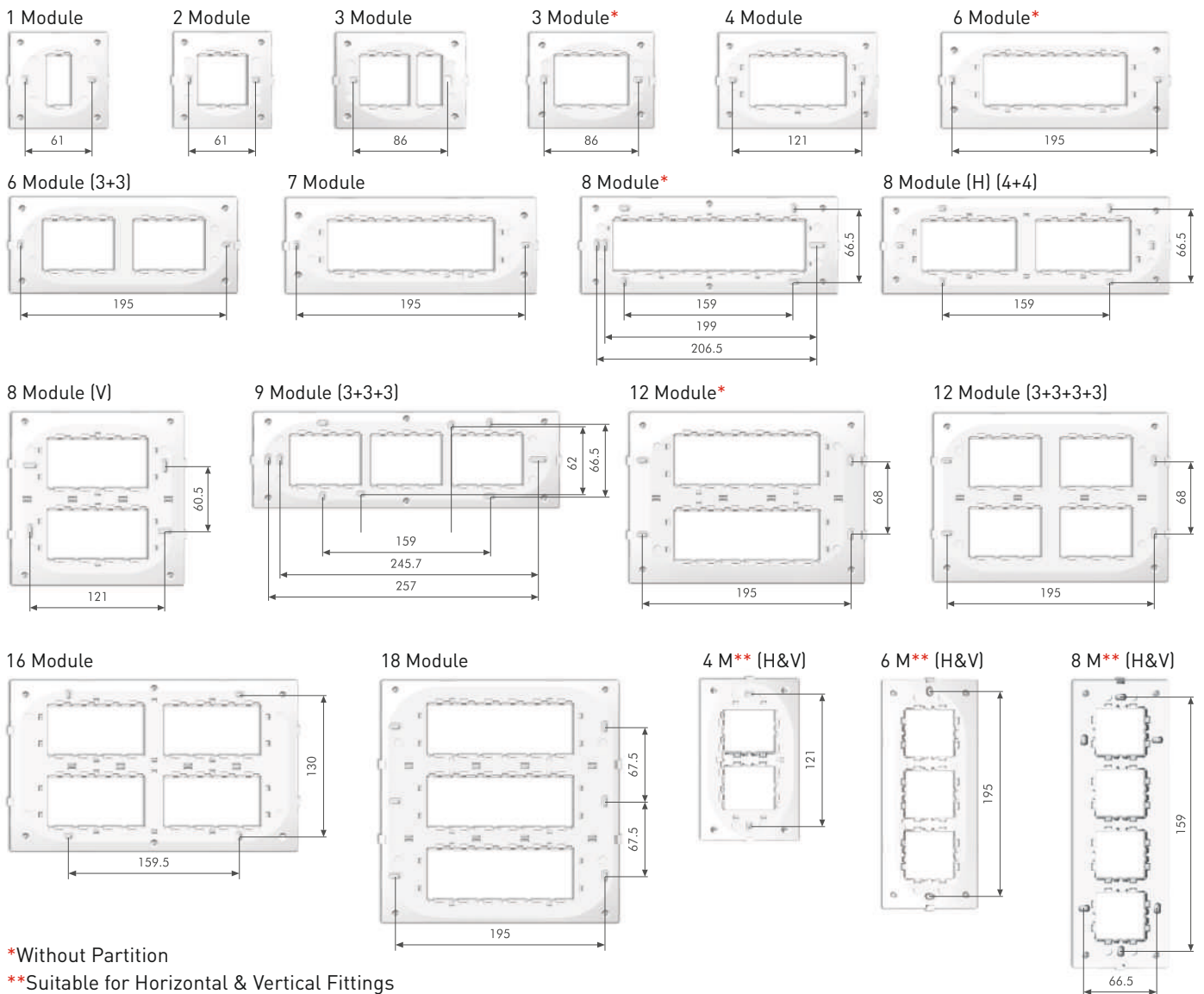

*Without Partition

**Suitable for Horizontal & Vertical Fittings

CASABLANCA

CASABLANCA - COVER PLATES (with Support Frame)

MODULES	1M	2M	3M	3M*	4M	6M
HSN CODE	8538	8538	8538	8538	8538	8538
PLATES	MRP ₹	MRP ₹	MRP ₹	MRP ₹	MRP ₹	MRP ₹
GLOSSY WHITE	PK SB 01 001 112.00	PK SB 02 002 112.00	PK SB 03 003 134.00	PK SB 03 009 134.00	PK SB 04 004 158.00	PK SB 06 005 199.00
METALIK	PM SB 01 001 189.00	PM SB 02 002 189.00	PM SB 03 003 244.00	PM SB 03 009 244.00	PM SB 04 004 285.00	PM SB 06 005 358.00
SOFT	PL SB 01 001 177.00	PL SB 02 002 177.00	PL SB 03 003 230.00	PL SB 03 009 230.00	PL SB 04 004 268.00	PL SB 06 005 347.00
CANDY	PO SB 01 001 189.00	PO SB 02 002 189.00	PO SB 03 003 244.00	PO SB 03 009 244.00	PO SB 04 004 285.00	PO SB 06 005 358.00
WOOD	PN SB 01 001 222.00	PN SB 02 002 222.00	PN SB 03 003 295.00	PN SB 03 009 295.00	PN SB 04 004 347.00	PN SB 06 005 407.00
SNAPZ	PP SB 01 001 156.00	PP SB 02 002 156.00	—	PP SB 03 009 196.00	PP SB 04 004 244.00	PP SB 06 005 318.00
DISNEY	PQ SB 01 001 193.00	PQ SB 02 002 193.00	—	PQ SB 03 009 231.00	PQ SB 04 004 285.00	PQ SB 06 005 344.00
STD. PKG.	20/300	20/300	20/300	20/300	20/300	10/150
SIZE (mm)	93 x 86	93 x 86	123 x 86	116 x 86	151 x 86	219 x 86

CASABLANCA - COVER PLATES (Dimensions in mm)

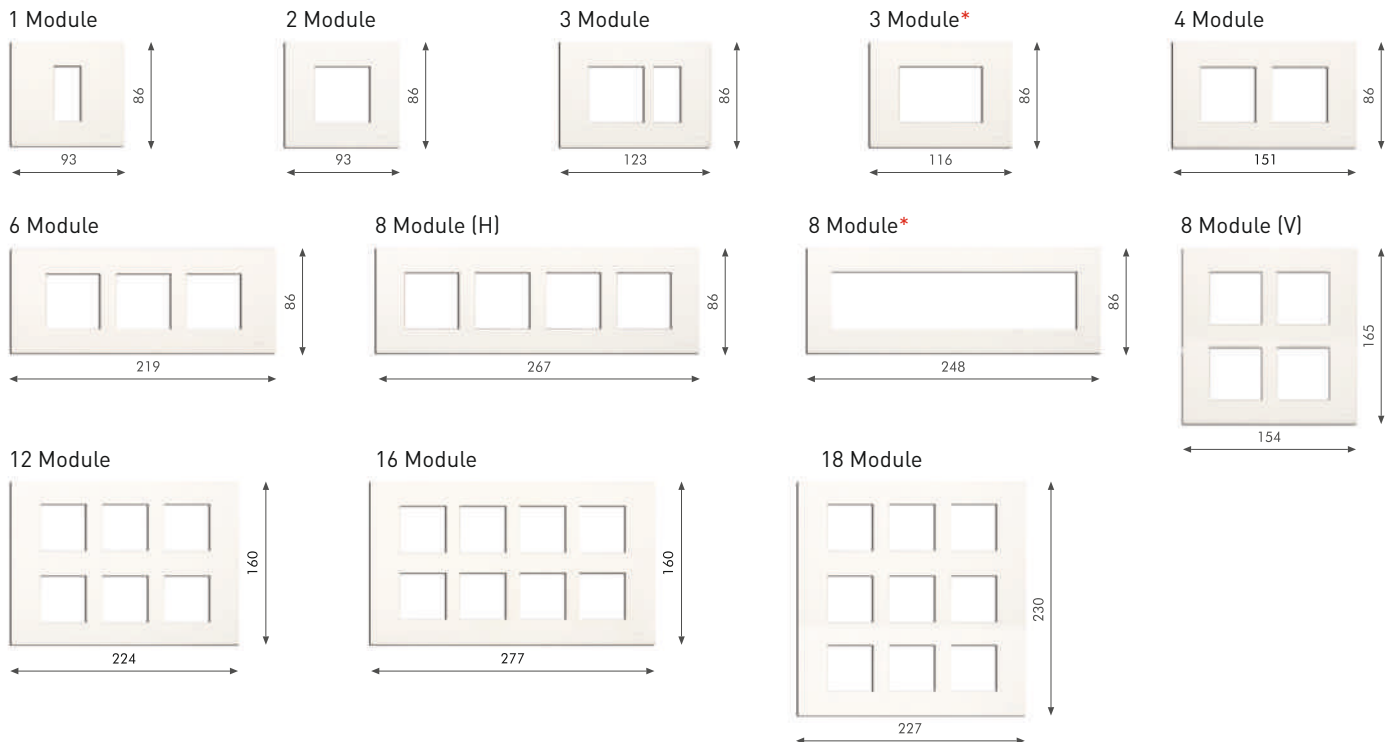

8M(H)	8M*	8M(V)	12M	16M	18M
8538	8538	8538	8538	8538	8538
MRP ₹	MRP ₹	MRP ₹	MRP ₹	MRP ₹	MRP ₹
PK SB 08 006 252.00	PK SB 08 011 284.00	PK SB 08 012 252.00	PK SB 12 007 311.00	PK SB 16 008 354.00	PK SB 18 010 413.00
PM SB 08 006 437.00	PM SB 08 011 437.00	PM SB 08 012 437.00	PM SB 12 007 510.00	PM SB 16 008 575.00	PM SB 18 010 672.00
PL SB 08 006 418.00	PL SB 08 011 418.00	PL SB 08 012 418.00	PL SB 12 007 492.00	PL SB 16 008 553.00	PL SB 18 010 638.00
PO SB 08 006 437.00	PO SB 08 011 437.00	PO SB 08 012 437.00	PO SB 12 007 510.00	PO SB 16 008 575.00	PO SB 18 010 672.00
PN SB 08 006 502.00	PN SB 08 011 502.00	PN SB 08 012 502.00	PN SB 12 007 601.00	PN SB 16 008 676.00	PN SB 18 010 761.00
PP SB 08 006 450.00	—	—	—	—	—
PQ SB 08 006 475.00	—	—	—	—	—
10/150	10/150	10/150	10/80	10/80	10/80
267 x 86	248 x 86	154 x 165	224 x 160	277 x 160	227 x 230

CASABLANCA - SUPPORT FRAMES - Horizontal & Vertical for Fixing (Dimensions in mm)

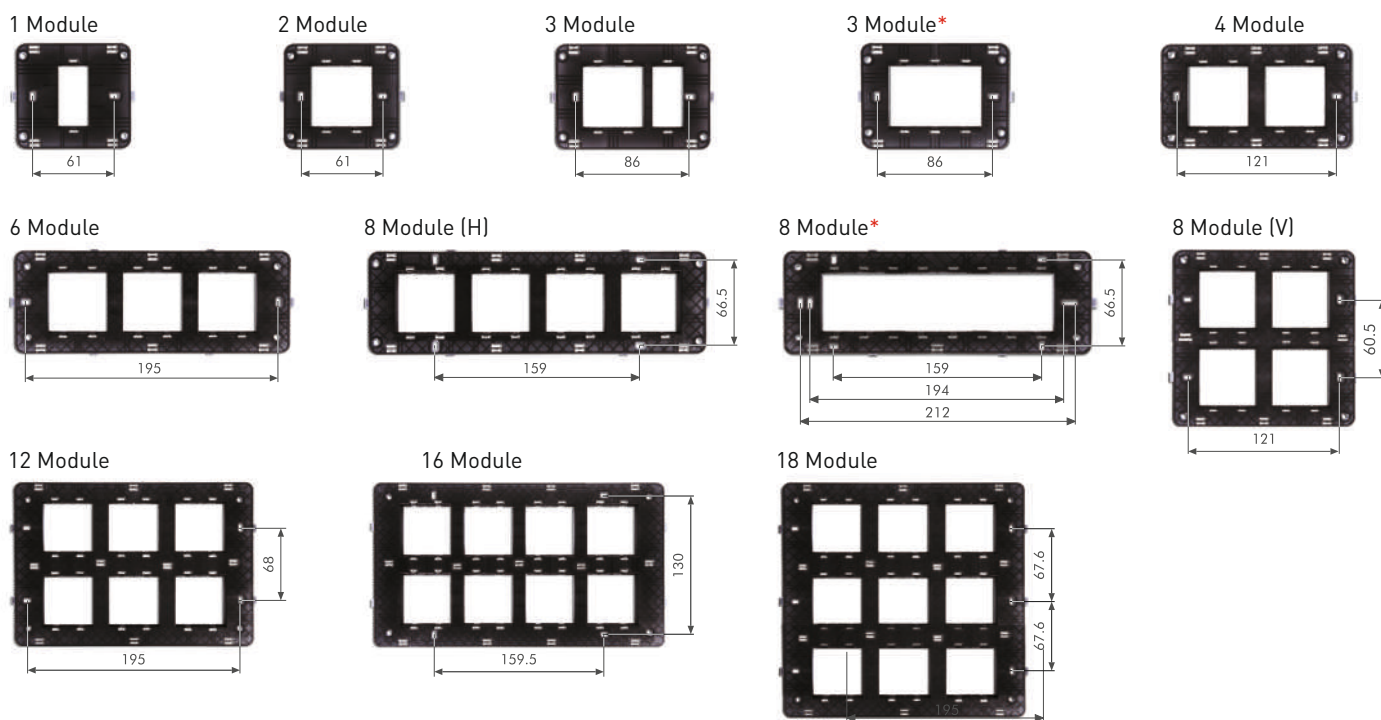

*Without Partition

NATURALZ - COVER PLATES (without Support Frame)

MODULES	1M	2M	3M	4M	6M	7M
HSN CODE	8538	8538	8538	8538	8538	8538
PLATES	MRP ₹	MRP ₹	MRP ₹	MRP ₹	MRP ₹	MRP ₹
REGULAR GLOSSY	PU 01 013 144.00	PU 02 001 144.00	PU 03 002 181.00	PU 04 004 226.00	PU 06 005 269.00	PU 07 006 287.00
REGULAR METALIK	PV 01 013 210.00	PV 02 001 210.00	PV 03 002 231.00	PV 04 004 271.00	PV 06 005 310.00	PV 07 006 327.00
REGULAR WOOD	PW 01 013 245.00	PW 02 001 245.00	PW 03 002 272.00	PW 04 004 339.00	PW 06 005 378.00	PW 07 006 394.00
EXCLUSIVE GLASZ	PC 01 013 490.00	PC 02 001 490.00	PC 03 002 705.00	PC 04 004 937.00	PC 06 005 1226.00	PC 07 006 1320.00
EXCLUSIVE CRYSTALLINE	PD 01 013 551.00	PD 02 001 551.00	PD 03 002 793.00	PD 04 004 1056.00	PD 06 005 1380.00	PD 07 006 1488.00
EXCLUSIVE DIVINITY	—	—	PE 03 002 695.00	—	—	—
EXCLUSIVE CORPORATE	—	—	PH 03 002 4800.00	—	—	—
EXCLUSIVE SWAROVSKI	—	—	PF 03 002 9000.00	—	—	—
STD. PKG.	10	10	10	10	5	5
SIZE (mm)	93 x 86	93 x 86	116 x 86	151 x 86	219 x 86	219 x 86

NATURALZ - SUPPORT FRAMES

MODULES	1M	2M	3M	4M	6M	7M
HSN CODE	8538	8538	8538	8538	8538	8538
PLATES	MRP ₹	MRP ₹	MRP ₹	MRP ₹	MRP ₹	MRP ₹
TR - BLACK	SC 01 013 54.00	SC 02 001 54.00	SC 03 002 65.00	SC 04 004 75.00	SC 06 005 105.00	SC 07 006 117.00
STD./MST PKG.	10/600	10/600	10/600	10/450	10/300	10/300

NATURALZ - COVER PLATES (Dimensions in mm)

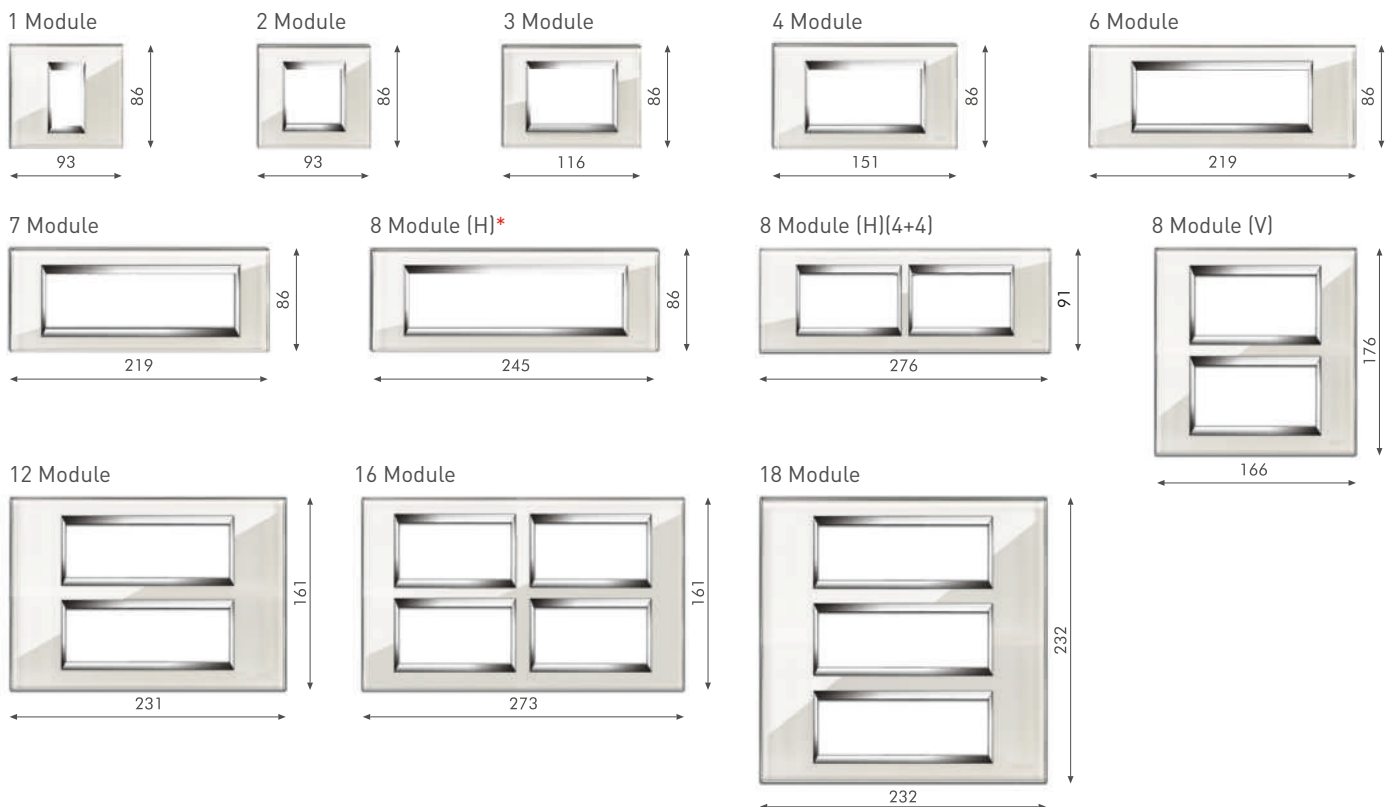

8M(H)*	8M(H)(4+4)	8M(V)	12M	16M	18M
8538	8538	8538	8538	8538	8538
MRP ₹	MRP ₹	MRP ₹	MRP ₹	MRP ₹	MRP ₹
PU 08 008 342.00	PU 08 009 342.00	PU 08 010 342.00	PU 12 011 464.00	PU 16 007 487.00	PU 18 012 606.00
PV 08 008 396.00	PV 08 009 396.00	PV 08 010 396.00	PV 12 011 544.00	PV 16 007 596.00	PV 18 012 667.00
PW 08 008 490.00	PW 08 009 490.00	PW 08 010 490.00	PW 12 011 667.00	PW 16 007 774.00	PW 18 012 885.00
PC 08 008 1434.00	PC 08 009 1434.00	PC 08 010 1434.00	PC 12 011 1731.00	PC 16 007 1884.00	PC 18 012 2101.00
PD 08 008 1618.00	PD 08 009 1618.00	PD 08 010 1618.00	PD 12 011 1953.00	PD 16 007 2140.00	PD 18 012 2394.00
—	—	—	—	—	—
—	—	—	—	—	—
—	—	—	—	—	—
5	5	5	5	5	5
245 x 86	276 x 91	166 x 176	231 x 161	273 x 161	232 x 232

8M(H)*	8M(H)(4+4)	8M(V)	12M	16M	18M
8538	8538	8538	8538	8538	8538
MRP ₹	MRP ₹	MRP ₹	MRP ₹	MRP ₹	MRP ₹
SC 08 008 138.00	SC 08 009 138.00	SC 08 010 138.00	SC 12 011 177.00	SC 16 007 216.00	SC 18 012 236.00
10/300	10/300	10/300	10/150	10/150	10/150

NATURALZ - SUPPORT FRAMES - Horizontal & Vertical for Fixing (Dimensions in mm)

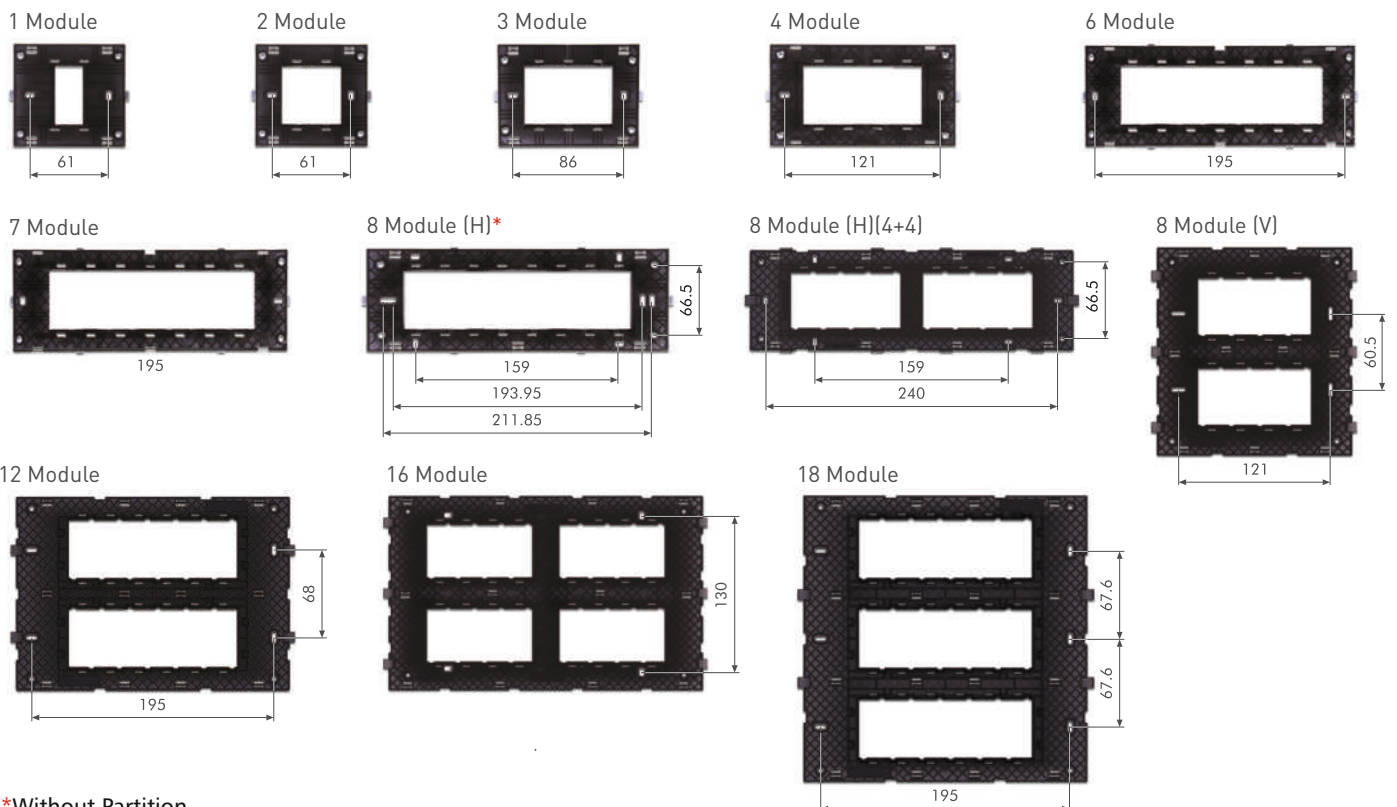

*Without Partition

WAVIO - COVER PLATES (with Support Frame)

MODULES →	1M	2M	3M	4M	6M	8M
HSN CODE	8538	8538	8538	8538	8538	8538
PLATES ↓	MRP ₹	MRP ₹	MRP ₹	MRP ₹	MRP ₹	MRP ₹
GLOSSY	CC SI 01 001 182.00	CC SI 02 002 182.00	CC SI 03 003 241.00	CC SI 04 004 291.00	CC SI 06 005 366.00	CC SI 08 007 456.00
METALIK	CF SI 01 001 254.00	CF SI 02 002 254.00	CF SI 03 003 297.00	CF SI 04 004 361.00	CF SI 06 005 414.00	CF SI 08 007 509.00
WOOD	CG SI 01 001 291.00	CG SI 02 002 291.00	CG SI 03 003 340.00	CG SI 04 004 403.00	CG SI 06 005 476.00	CG SI 08 007 605.00
LEATHER	CK SI 01 001 240.00	CK SI 02 002 240.00	CK SI 03 003 280.00	CK SI 04 004 340.00	CK SI 06 005 390.00	CK SI 08 007 480.00
STD./MST PKG.	10/300	10/300	10/300	10/300	5/150	5/150
SIZE (mm)	97 x 93	97 x 93	120 x 93	151 x 93	220 x 93	253 x 93

WAVIO - COVER PLATES (Dimensions in mm)

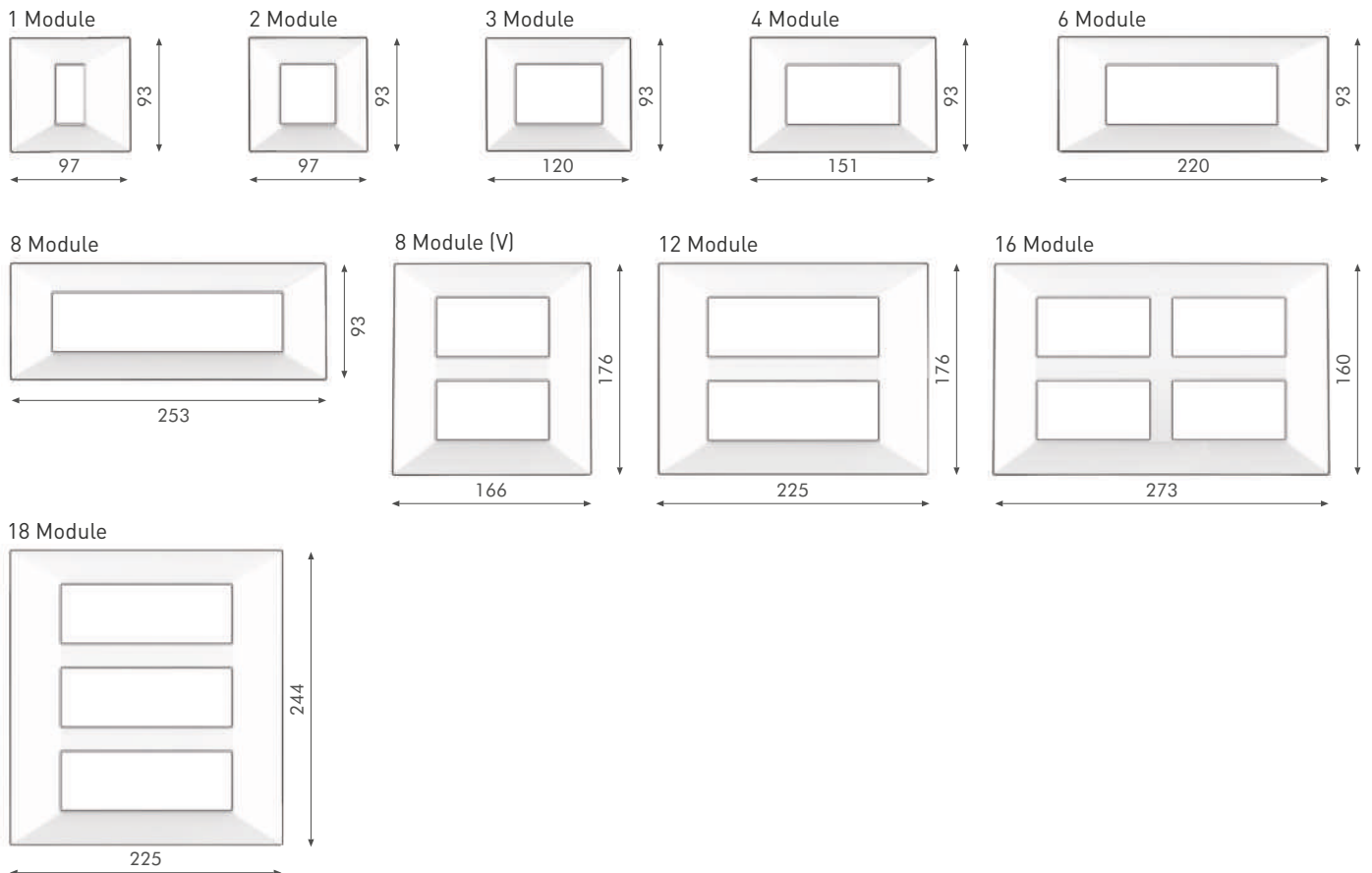

8M(V)	12M	16M	18M		
8538	8538	8538	8538		
MRP ₹	MRP ₹	MRP ₹	MRP ₹		
CC SI 08 009 456.00	CC SI 12 010 562.00	CC SI 16 006 693.00	CC SI 18 011 790.00		
CF SI 08 009 509.00	CF SI 12 010 690.00	CF SI 16 006 793.00	CF SI 18 011 881.00		
CG SI 08 009 605.00	CG SI 12 010 796.00	CG SI 16 006 938.00	CG SI 18 011 1051.00		
CK SI 08 009 480.00	CK SI 12 010 650.00	CK SI 16 006 770.00	CK SI 18 011 830.00		
5/150	5/50	5/50	5/50		
166 x 176	225 x 176	273 x 160	225 x 244		

WAVIO - SUPPORT FRAMES (Dimensions in mm)

1 Module



2 Module

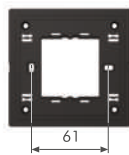

3 Module

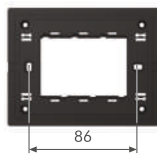

4 Module

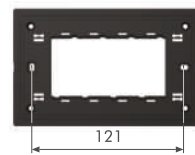

6 Module

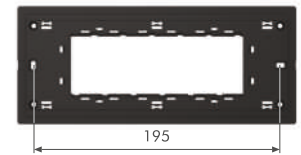

8 Module

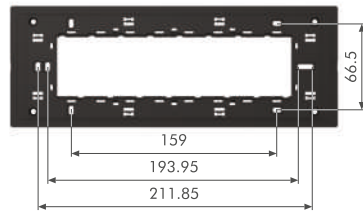

8 Module (V)

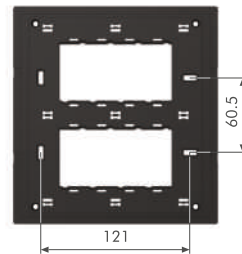

12 Module

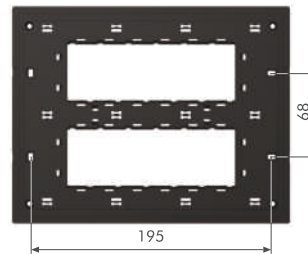

16 Module

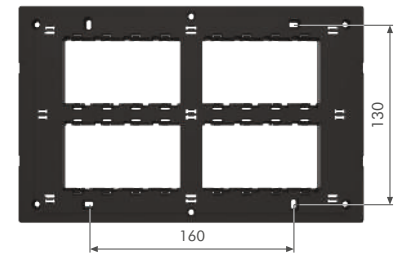

18 Module

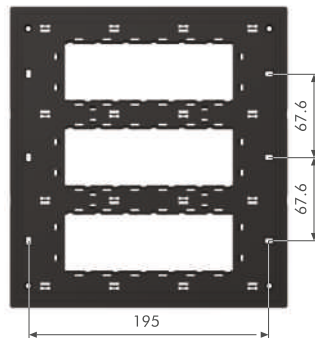

ARKIOS - COVER PLATES (with Support Frame)

MODULES	1M	2M	3M	4M	6M	8M
HSN CODE	8538	8538	8538	8538	8538	8538
PLATES	MRP ₹	MRP ₹	MRP ₹	MRP ₹	MRP ₹	MRP ₹
GLOSSY	CH SH 01 001 165.00	CH SH 02 002 165.00	CH SH 03 003 216.00	CH SH 04 004 262.00	CH SH 06 005 325.00	CH SH 08 007 410.00
METALIK	CI SH 01 001 249.00	CI SH 02 002 249.00	CI SH 03 003 290.00	CI SH 04 004 350.00	CI SH 06 005 405.00	CI SH 08 007 500.00
WOOD	CJ SH 01 001 281.00	CJ SH 02 002 281.00	CJ SH 03 003 333.00	CJ SH 04 004 389.00	CJ SH 06 005 458.00	CJ SH 08 007 595.00
STD./MST PKG.	10/300	10/300	10/300	10/300	5/150	5/150
SIZE (mm)	103 x 96	103 x 96	126 x 96	151 x 96	226 x 96	250 x 96

ARKIOS - COVER PLATES (Dimensions in mm)

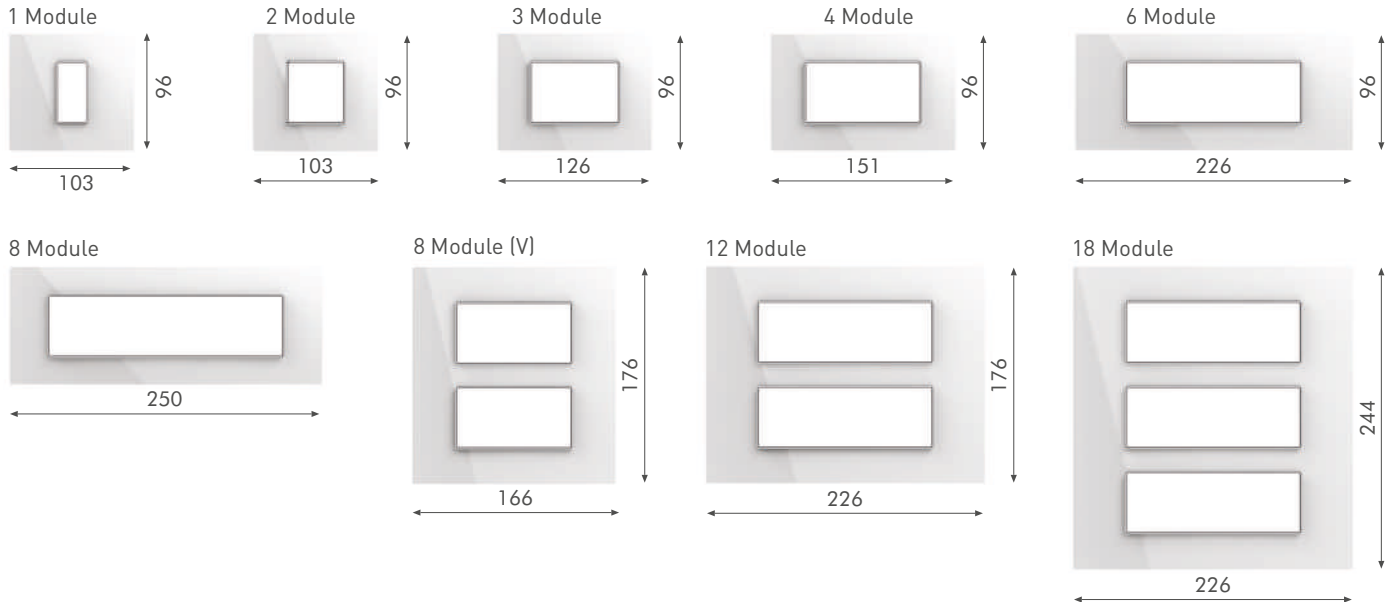

8M(V)	12M	18M			
8538	8538	8538			
MRP ₹	MRP ₹	MRP ₹			
CH SH 08 009 410.00	CH SH 012 010 538.00	CH SH 18 011 708.00			
CI SH 08 009 500.00	CI SH 12 010 676.00	CI SH 18 011 888.00			
CJ SH 08 009 595.00	CJ SH 12 010 782.00	CJ SH 18 011 1036.00			
5/150	5/50	5/50			
166 x 176	226 x 176	226 x 244			

ARKIOS - SUPPORT FRAMES (Dimensions in mm)

1 Module

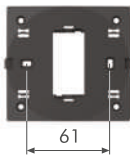

2 Module

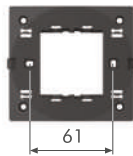

3 Module

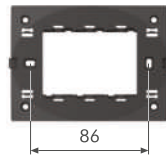

4 Module

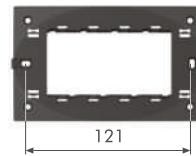

6 Module

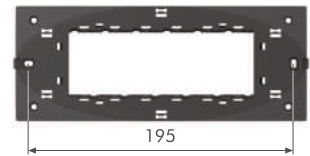

8 Module

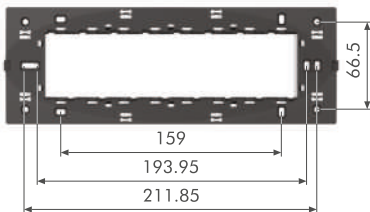

8 Module (V)

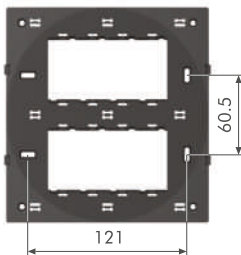

12 Module

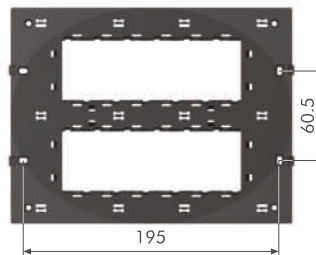

18 Module

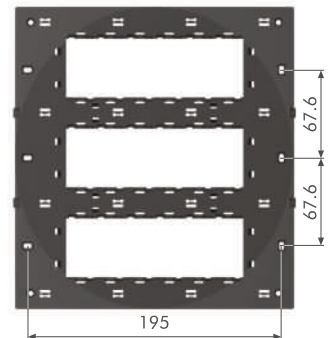

FOREST - COVER PLATES (with Support Frame) - Suitable for wooden and metal box

MODULES	1M*	2M*	3M*	4M*	4M*	6M*	8M*	10M
HSN CODE	8538	8538	8538	8538	8538	8538	8538	8538
PLATES	MRP ₹	MRP ₹	MRP ₹	MRP ₹	MRP ₹	MRP ₹	MRP ₹	MRP ₹
PURE GLOSSY	CP SN 01 001 87.00	CP SN 02 002 87.00	CP SN 03 003 110.00	CP SN 04 004 149.00	CP SN 04 015 149.00	CP SN 06 005 191.00	CP SN 08 006 250.00	CP SN 10 013 284.00
GLOSSY	CM SN 01 001 87.00	CM SN 02 002 87.00	CM SN 03 003 110.00	CM SN 04 004 149.00	CM SN 04 015 149.00	CM SN 06 005 191.00	CM SN 08 006 250.00	CM SN 10 013 284.00
METALIK	CN SN 01 001 137.00	CN SN 02 002 137.00	CN SN 03 003 172.00	CN SN 04 004 215.00	CN SN 04 015 215.00	CN SN 06 005 284.00	CN SN 08 006 364.00	CN SN 10 013 409.00
WOOD	CO SN 01 001 181.00	CO SN 02 002 181.00	CO SN 03 003 227.00	CO SN 04 004 273.00	CO SN 04 015 273.00	CO SN 06 005 374.00	CO SN 08 006 506.00	CO SN 10 013 533.00
STD./MST PKG.	20/400	20/400	20/400	20/300	20/300	10/200	10/200	10/150
SIZE (inch)	4.5 x 4.5	4.5 x 4.5	4.5 x 5.0	4.5 x 6.5	4.5 x 7.5	4.5 x 8.5	4.5 x 10.5	4.5 x 12.5

FOREST - COVER PLATES (Dimensions in inch) - Suitable for wooden and metal box



*Suitable for Metal Box
 **Suitable for Horizontal & Vertical Fittings

12M (H)	12M (V)*	12M (H&V)	16M*	18M*	18M (H&V)	20M	24M
8538	8538	8538	8538	8538	8538	8538	8538
MRP ₹	MRP ₹	MRP ₹	MRP ₹	MRP ₹	MRP ₹	MRP ₹	MRP ₹
CP SN 12 014 301.00	CP SN 12 008 301.00	CP SN 12 016 301.00	CP SN 16 009 323.00	CP SN 18 010 381.00	CP SN 18 017 381.00	CP SN 20 011 443.00	CP SN 24 012 545.00
CM SN 12 014 301.00	CM SN 12 008 301.00	CM SN 12 016 301.00	CM SN 16 009 323.00	CM SN 18 010 381.00	CM SN 18 017 381.00	CM SN 20 011 443.00	CM SN 24 012 545.00
CN SN 12 014 448.00	CN SN 12 008 448.00	CN SN 12 016 448.00	CN SN 16 009 482.00	CN SN 18 010 516.00	CN SN 18 017 516.00	CN SN 20 011 607.00	CN SN 24 012 726.00
CO SN 12 014 585.00	CO SN 12 008 585.00	CO SN 12 016 585.00	CO SN 16 009 653.00	CO SN 18 010 709.00	CO SN 18 017 709.00	CO SN 20 011 789.00	CO SN 24 012 891.00
10/120	10/120	10/120	10/90	10/120	10/120	10/80	10/80
4.5 x 15.5	6.5 x 8.5	6.5 x 8.5	6.5 / 7.5 x 10.5	8.5 x 10.5	8.5 x 10.5	6.5 x 12.5	9.5 x 12.5

FOREST - SUPPORT FRAMES (Dimensions in mm)

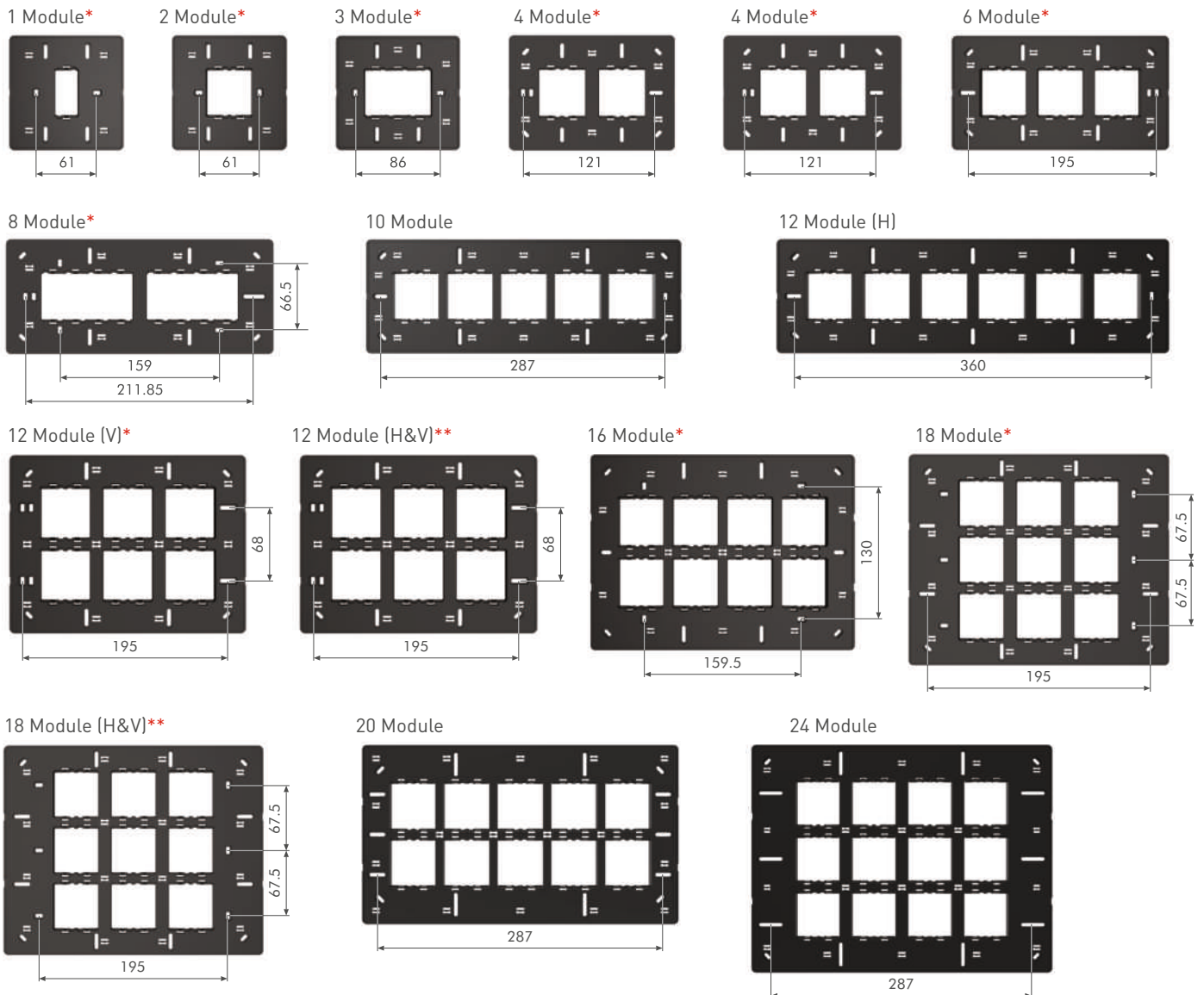

FLUSH MOUNTING METAL GANG BOX (Galvanised)

MODULE	1&2M	3M	4M	6M	8M(H)	8M(V)	12M	16M	18M
HSN CODE	8538	8538	8538	8538	8538	8538	8538	8538	8538
GANG BOX	MRP ₹	MRP ₹	MRP ₹	MRP ₹	MRP ₹	MRP ₹	MRP ₹	MRP ₹	MRP ₹
	JM 02 001 74.00	JM 03 002 98.00	JM 04 003 120.00	JM 06 004 145.00	JM 08 005 193.00	JM 08 006 193.00	JM 12 008 240.00	JM 16 009 300.00	JM 18 010 342.00
STD./MST PKG.	10/120	10/120	10/120	5/80	5/60	5/60	5/45	5/45	5/40
SIZE WxHxL (mm)	77x75x50	102x75x52	137x75x52	210x75x52	232x75x52	137x132x61	211x132x61	232x146x61	211x202x61



1&2 Module



3 Module



4 Module



6 Module



8 Module (H)



8 Module (V)



12 Module



16 Module



18 Module

FLUSH MOUNTING PLASTIC GANG BOX (Fire Resistant)

MODULE	1&2M	3M	4M	6M	8M(H)	8M(V)	12M	16M	18M
HSN CODE	8538	8538	8538	8538	8538	8538	8538	8538	8538
GANG BOX	MRP ₹	MRP ₹	MRP ₹	MRP ₹	MRP ₹	MRP ₹	MRP ₹	MRP ₹	MRP ₹
	JP 02 001 61.00	JP 03 002 71.00	JP 04 003 85.00	JP 06 004 111.00	JP 08 005 128.00	JP 08 006 128.00	JP 12 008 178.00	JP 16 009 209.00	JP 18 010 253.00
STD./MST PKG.	10/300	10/300	10/300	5/100	5/100	5/100	5/60	5/60	5/60
SIZE WxHxL (mm)	81x84x58	106x84x58	141x84x58	215x84x58	243x84x58	141x141x58	215x144x58	245x153x63	215x215x63



1&2 Module

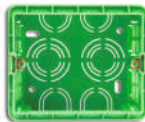

3 Module

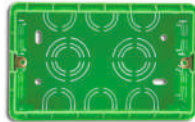

4 Module



6 Module

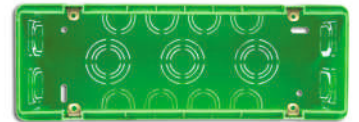

8 Module (H)

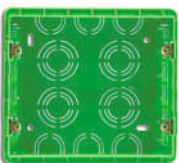

8 Module (V)

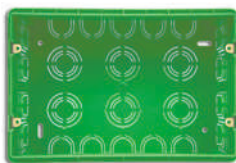

12 Module

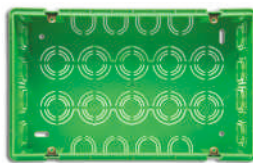

16 Module

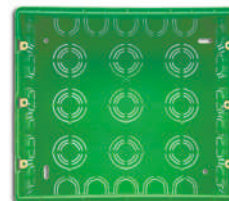

18 Module

SLIM SURFACE MOUNTING PLASTIC GANG BOX

MODULE ▶	1&2M	3M	4M	6M	8M(H)	8M(V)	12M	16M	18M
HSN CODE	8538	8538	8538	8538	8538	8538	8538	8538	8538
GANG BOX ▼	MRP ₹	MRP ₹	MRP ₹	MRP ₹	MRP ₹	MRP ₹	MRP ₹	MRP ₹	MRP ₹
	JS 02 101 69.00	JS 03 102 105.00	JS 04 103 116.00	JS 06 104 146.00	JS 08 105 191.00	JS 08 106 191.00	JS 12 108 235.00	JS 16 109 272.00	JS 18 110 318.00
STD./MST PKG.	10/300	10/300	10/300	5/100	5/100	5/60	5/60	5/60	5/60
SIZE WxHxL (mm)	92x87x48	117x87x48	150x87x48	220x87x48	245x87x48	150x165x48	222x160x48	273x160x48	222x224x48



1&2 Module



3 Module



4 Module



6 Module



8 Module (H)



8 Module (V)



12 Module



16 Module



18 Module



Express what's within your heart.

COLOURS & MATERIALS

We respond instantly and instinctively to colour. The hues of orange give you the warmth and the shades of blue that cools your mood. Red that excites the passion and white that settles you in peace. Colours have that energy to make a design speak.

CASAVIVA

PURE GLOSSY



White

GLOSSY



White



Black



Ivory



Grey

METALIK



Hawana Gold



Brazil Silver



Graphite Magnesia

WOOD



Walnut



Wenge

CASABLANCA

WHITE



Glossy White

METALIK



Vegas Gold



Silver Strokes



Platinum Grey



Irish Coffee



Sterling Silver



Graphite Magnesia

SOFT



London Blue



Magic Grey



Black Currant

CANDY



Summer Wine



Herbal Green



Orange Peel



Cool Coffee

WOOD



African Wenge



Italian Walnut



Burma Teak



Dark Oak

SNAPZ



Snapz

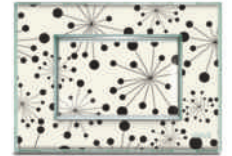

Wallpaper

Disney



Pooh

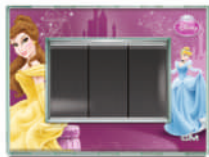

Princess



Snow White



Minnie



Mickey

naturalz

REGULAR GLOSSY



Silk White



Silk Black

REGULAR METALIK



Silver Hue



Graphite Magnesia

REGULAR WOOD



Carbon Wood



Tulip Wood

EXCLUSIVE GLASZ



White Ice



Green Ice



Silver Mirror



Grey Ice



Chocolate Ice



Amber Ice



Orange Ice



Black Ice



Red Ice

EXCLUSIVE CRYSTALLINE



Crystalline Silver



Crystalline Bronze



Crystalline Bronze Matt



Crystalline White



Crystalline Black



Crystalline Gold Mirror



Crystalline Gold Matt



Crystalline Grey Mirror



Crystalline Grey Matt

EXCLUSIVE CRYSTALLINE **NEW**



Chrome Mirror



Green Mirror



Magenta Mirror



Blue Mirror



Green Matt



Blue Matt



Slate Matt

EXCLUSIVE DIVINITY



White



Black

EXCLUSIVE CORPORATE



Black

SWAROVSKI



Crystal Goldshine



Crystal Yellow Amber



Sparkling Chrome Rock



Sizzling Magna Red



Mysterious Black Rock

Wavio

GLOSSY



Sparkling White



Sparkling Black



Sparkling Red

METALIK



Gold



Rose Gold



Black Gold



Silver



Green



Graphite Magnesia

WOOD



Wenge



Walnut



Carbon Wood

LEATHER



Elite White



Onyx Black



Mystic Blue



Pebble Grey



Caramel Brown



Bistre Brown

Arkios

GLOSSY



Sparkling White



Sparkling Black



Sparkling Red

METALIK



Gold



Rose Gold



Black Gold



Silver



Graphite Magnesia

WOOD



Wenge



Walnut



Carbon Wood

FOREST

PURE GLOSSY



Pure Glossy

GLOSSY



White



Ivory

METALIK



Silver



Graphite Magnesia

WOOD



Wenge

Article and cover plates Customization

Often, the market requests the possibility to personalize the front part of the covers with symbols or inscriptions, or the personalization of the front plates with identifying marks. These marks are required to enhance the prestige and image.

GM offers the possibility to produce inscriptions, symbols, logos or special marks on the articles or cover plates. The personalization is done by laser technology. Laser technology allows the reproduction of any name, logotype or trademark, with absolute precision and indelibility even for small quantities.

Examples



COVER PLATE



SMART CARD



SIGNAGE SLIDE (AA 3 161 MA)



SIGNAGE SLIDE (AA 3 123 MA)

Request of Customization

- Cover plates and Smart card - Please supply the image in EPS or TIFF format through e-mail/CD.
- Edge Glow LED Signage Slides - While ordering engraving of customized symbols on slides, wherever possible, reference should be made of the product code along with the number of symbol. (e.g. AA 3 123 MA / AA 3 161 MA means signage edge glow square slide with EXIT direction symbol).
- Please contact the customer service department for feasibility, quality and delivery time.

Symbols for customizable slides of LED Signage & Edge Glow LED Signage (Laser engraving)



Your name
is your
legacy.



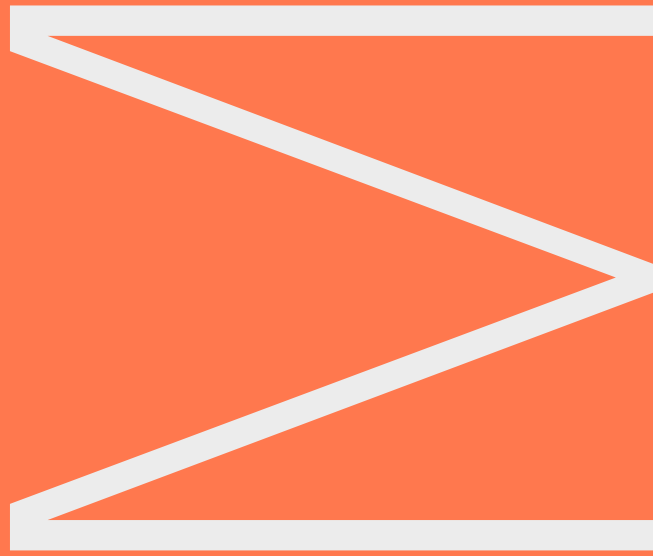

ULTRA



Delivering a thrilling experience!

DESIGNER SWITCH PLATES

G-X is an idea of creating with the best intentions to give you the most comforting experience all around your home. Starting from revolutionary switches, tailor-made regulators, torch-like night lamps to innovative step-markers and more. The G-X range is by far the most contemporary and the most evolved rendition of today, and is all set to deliver a thrilling experience to you.

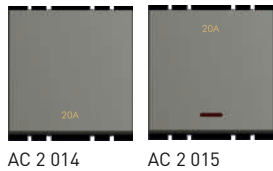
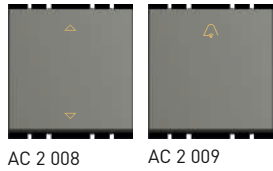
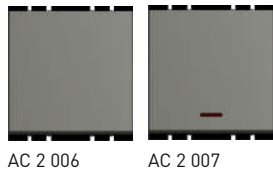
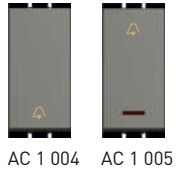
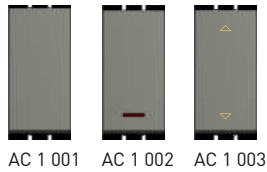

CODE	HSN CODE	ITEM	MRP ₹		
			GLOSSY WHITE	GRAPHITE MAGNESIA TITANIUM SILVER	STD./MST. PKG.
10AX ACE SWITCHES 240V~ 1 MODULE					
AC 1 001	8536	1 Way Switch	55.00	64.00	20/600
AC 1 002	8536	1 Way Switch with Indicator (LED)	102.00	119.00	20/600
AC 1 003	8536	2 Way Switch	102.00	119.00	20/600
AC 1 004	8536	Bell Push Switch	111.00	130.00	20/600
AC 1 005	8536	Bell Push Switch with Indicator (LED)	125.00	147.00	20/600
10AX ACE SWITCHES 240V~ 2 MODULE					
AC 2 006	8536	1 Way Switch	119.00	141.00	10/300
AC 2 007	8536	1 Way Switch with Indicator (LED)	146.00	173.00	10/300
AC 2 008	8536	2 Way Switch	146.00	173.00	10/300
AC 2 009	8536	Bell Push Switch	141.00	166.00	10/300
AC 2 010	8536	Bell Push Switch with Indicator (LED)	158.00	187.00	10/300
20AMP ACE SWITCHES 240V~ 1 MODULE					
AC 1 011	8536	1 Way Switch	127.00	152.00	20/600
AC 1 012	8536	1 Way Switch with Indicator (LED)	165.00	195.00	20/600
AC 1 013	8536	2 Way Switch	165.00	195.00	20/600
20AMP ACE SWITCHES 240V~ 2 MODULE					
AC 2 014	8536	1 Way Switch	157.00	184.00	10/300
AC 2 015	8536	1 Way Switch with Indicator (LED)	180.00	212.00	10/300
AC 2 016	8536	2 Way Switch	180.00	212.00	10/300
32AMP ACE DOUBLE POLE SWITCH 240V~ 2 MODULE					
AC 2 024	8536	DP Switch with Indicator (NEON)	281.00	332.00	10/300

CODE	HSN CODE	ITEM	MRP ₹		STD./ MST. PKG.
			GLOSSY WHITE	GRAPHITE MAGNESIA TITANIUM SILVER	
10AX AXON SWITCHES 240V~ 1 MODULE					
AC 1 201	8536	1 Way Switch	65.00	74.00	20/600
AC 1 202	8536	1 Way Switch with Indicator (LED)	105.00	122.00	20/600
AC 1 203	8536	2 Way Switch	105.00	122.00	20/600
AC 1 204	8536	Bell Push Switch	115.00	134.00	20/600
AC 1 205	8536	Bell Push Switch with Indicator (LED)	129.00	152.00	20/600
10AX AXON SWITCHES 240V~ 2 MODULE					
AC 2 206	8536	1 Way Switch	122.00	145.00	10/300
AC 2 207	8536	1 Way Switch with Indicator (LED)	151.00	178.00	10/300
AC 2 208	8536	2 Way Switch	151.00	178.00	10/300
AC 2 209	8536	Bell Push Switch	145.00	171.00	10/300
AC 2 210	8536	Bell Push Switch with Indicator (LED)	163.00	192.00	10/300
20AMP AXON SWITCHES 240V~ 1 MODULE					
AC 1 211	8536	1 Way Switch	130.00	153.00	20/600
AC 1 212	8536	1 Way Switch with Indicator (LED)	159.00	188.00	20/600
AC 1 213	8536	2 Way Switch	159.00	188.00	20/600
20AMP AXON SWITCHES 240V~ 2 MODULE					
AC 2 214	8536	1 Way Switch	162.00	190.00	10/300
AC 2 215	8536	1 Way Switch with Indicator (LED)	186.00	218.00	10/300
AC 2 216	8536	2 Way Switch	186.00	218.00	10/300
32AMP AXON DOUBLE POLE SWITCH 240V~ 2 MODULE					
AC 2 224	8536	DP Switch with Indicator (NEON)	289.00	342.00	10/300

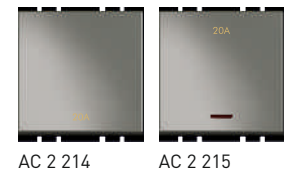
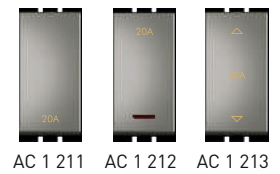
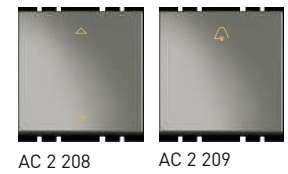
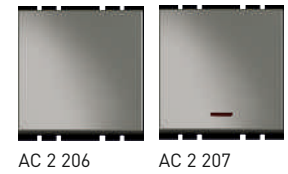
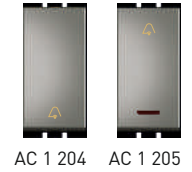
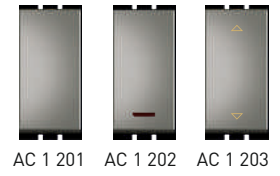

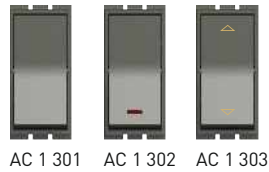

AC 1 301 AC 1 302 AC 1 303

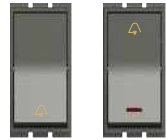

AC 1 304 AC 1 305

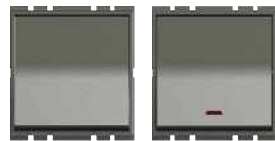

AC 2 306 AC 2 307



AC 2 308 AC 2 309



AC 2 310



AC 1 311 AC 1 312 AC 1 313



AC 2 314 AC 2 315



AC 2 316



AC 2 324

CODE	HSN CODE	ITEM	MRP ₹		
			GLOSSY WHITE	GRAPHITE MAGNESIA TITANIUM SILVER	STD./MST. PKG.
10AX AXELA SWITCHES 240V~ 1 MODULE					
AC 1 301	8536	1 Way Switch	53.00	62.00	20/600
AC 1 302	8536	1 Way Switch with Indicator (LED)	96.00	112.00	20/600
AC 1 303	8536	2 Way Switch	96.00	112.00	20/600
AC 1 304	8536	Bell Push Switch	105.00	123.00	20/600
AC 1 305	8536	Bell Push Switch with Indicator (LED)	118.00	140.00	20/600
10AX AXELA SWITCHES 240V~ 2 MODULE					
AC 2 306	8536	1 Way Switch	110.00	130.00	10/300
AC 2 307	8536	1 Way Switch with Indicator (LED)	136.00	160.00	10/300
AC 2 308	8536	2 Way Switch	136.00	160.00	10/300
AC 2 309	8536	Bell Push Switch	130.00	154.00	10/300
AC 2 310	8536	Bell Push Switch with Indicator (LED)	146.00	173.00	10/300
20AMP AXELA SWITCHES 240V~ 1 MODULE					
AC 1 311	8536	1 Way Switch	111.00	140.00	20/600
AC 1 312	8536	1 Way Switch with Indicator (LED)	153.00	180.00	20/600
AC 1 313	8536	2 Way Switch	153.00	180.00	20/600
20AMP AXELA SWITCHES 240V~ 2 MODULE					
AC 2 314	8536	1 Way Switch	145.00	171.00	10/300
AC 2 315	8536	1 Way Switch with Indicator (LED)	166.00	196.00	10/300
AC 2 316	8536	2 Way Switch	166.00	196.00	10/300
32AMP AXELA DOUBLE POLE SWITCH 240V~ 2 MODULE					
AC 2 324	8536	DP Switch with Indicator (NEON)	268.00	316.00	10/300

CODE	HSN CODE	ITEM	MRP ₹		
			GLOSSY WHITE	GRAPHITE MAGNESIA TITANIUM SILVER	STD./MST. PKG.
10AX O' CODE SWITCHES 240V~ 1 MODULE					
AC 1 421	8536	1 Way Switch (Left)	55.00	65.00	20/600
AC 1 424	8536	1 Way Switch (Right)	55.00	65.00	20/600
AC 1 422	8536	1 Way Switch with Indicator (LED)	95.00	115.00	20/600
AC 1 423	8536	2 Way Switch	95.00	115.00	20/600
10AX O' CODE SWITCHES - 2 SWITCH 240V~ 2 MODULE					
AC 2 406	8536	1 Way 2 Switch	110.00	130.00	10/300
AC 2 407	8536	1 Way 2 Switch with Indicator (LED)	190.00	230.00	10/300
AC 2 414	8536	2 Way 2 Switch	175.00	206.00	10/300
10AX O' CODE SWITCHES - 1 SWITCH 240V~ 2 MODULE					
AC 2 401	8536	1 Way Switch	99.00	116.00	10/300
AC 2 402	8536	1 Way Switch with Indicator (LED)	138.00	163.00	10/300
AC 2 403	8536	2 Way Switch	138.00	163.00	10/300
AC 2 404	8536	Bell Push Switch	136.00	160.00	10/300
AC 2 405	8536	Bell Push Switch with Indicator (LED)	150.00	177.00	10/300
20A O' CODE SWITCHES 240V~ 1 MODULE					
AC 1 426	8536	1 Way Switch	120.00	143.00	20/600
AC 1 427	8536	1 Way Switch with Indicator (LED)	156.00	184.00	20/600
AC 1 428	8536	2 Way Switch	156.00	184.00	20/600
20AMP O' CODE SWITCHES - 2 SWITCH 240V~ 2 MODULE					
AC 2 411	8536	1 Way 2 Switch	191.00	225.00	10/300
AC 2 412	8536	1 Way 2 Switch with Indicator (LED)	240.00	283.00	10/300
AC 2 415	8536	2 Way 2 Switch	292.00	336.00	10/300
20AMP O' CODE SWITCHES - 1 SWITCH 240V~ 2 MODULE					
AC 2 408	8536	1 Way Switch	149.00	175.00	10/300
AC 2 409	8536	1 Way Switch with Indicator (LED)	169.00	199.00	10/300
AC 2 410	8536	2 Way Switch	179.00	203.00	10/300
32AMP O' CODE DOUBLE POLE 1 SWITCH 240V~ 2 MODULE					
AC 2 413	8536	DP Switchwith Indicator (LED)	309.00	365.00	10/300
BLANK PLATE 1 MODULE					
AC 1 430	8536	Blank Plate	25.00	28.00	50/1500

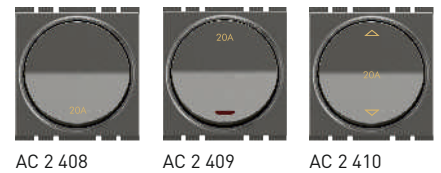
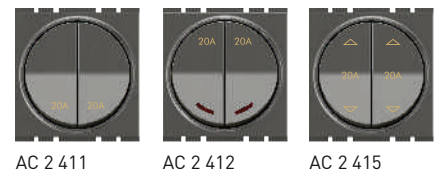
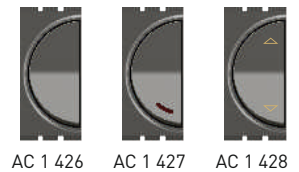
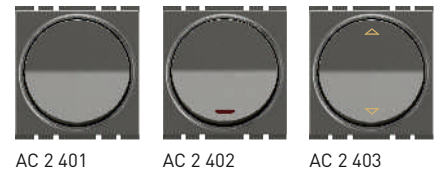
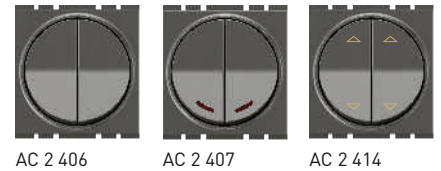

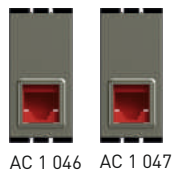
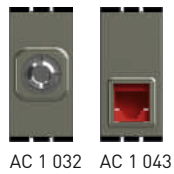
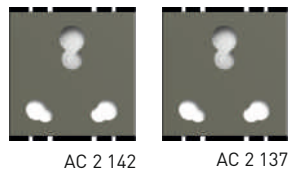
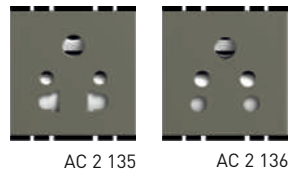
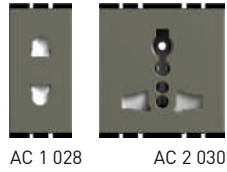
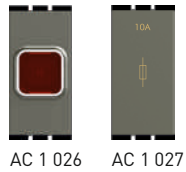

CODE	HSN CODE	ITEM	MRP ₹		STD./MST. PKG.
			GLOSSY WHITE	GRAPHITE MAGNESIA TITANIUM SILVER	
INDICATOR, FUSE UNIT 240V~ 1 MODULE					
AC 1 026	8536	Indicator with neon bulb holder	96.00	114.00	20/600
AC 1 027	8536	Fuse 10Amp with glass tube ø 6.3 x 28mm	137.00	161.00	20/600
6AMP/10AMP/13AMP SOCKETS 240 V~ 1 & 2 MODULE					
AC 1 028	8536	6Amp 2 Pin Euro-American Socket*	88.00	105.00	20/600
AC 2 030	8536	13Amp International Socket*	176.00	209.00	10/300
AC 2 135	8536	10Amp Universal Socket 2/3 Pin with mobile charger socket*	113.00	133.00	10/300
AC 2 136	8536	6Amp 2 in 1 socket* *with safety shutter	100.00	118.00	10/300
6 & 16AMP / 25AMP SOCKETS 240V~ 2 MODULE					
AC 2 142	8536	6 & 16Amp Universal Socket*	201.00	239.00	10/300
AC 2 137	8536	6 & 25Amp Universal Socket* *with safety shutter	216.00	255.00	10/300
TV SOCKET / RJ-11 TEL JACK - 1 MODULE					
AC 1 032	8536	TV Socket (Coaxial 40-862 MHZ Socket)	111.00	130.00	20/600
AC 1 043	8536	2 Line Jack, RJ-11	116.00	137.00	20/600
EDP SOCKETS - 1 MODULE					
AC 1 046	8536	EDP Socket Outlet - RJ 45 (Cat 5e)*	233.00	276.00	20/600
AC 1 047	8536	EDP Socket Outlet - RJ 45 (Cat 6) *insulation - piercing terminal	544.00	642.00	20/600
BLANK PLATE - 1 MODULE					
AC 1 052	8538	Blank Plate	25.00	28.00	50/1500

CODE	HSN CODE	ITEM	MRP ₹		STD./MST. PKG.
			GLOSSY WHITE	GRAPHITE MAGNESIA TITANIUM SILVER	
DIMMERS 240V~ 50Hz 1 & 2 MODULE					
AC 1 034	8533	Dimmer - 300 Watt	256.00	301.00	10/450
AC 2 035	8533	Dimmer - 300 Watt	329.00	386.00	10/300
AC 2 036	8533	Dimmer - 600 Watt	437.00	491.00	10/300
STEP FAN REGULATORS 240~ 50Hz 1 & 2 MODULE					
AC 1 039	8414	4 Step Fan Regulator (Full Rotary)	350.00	410.00	10/450
AC 2 040	8414	5 Step Fan Regulator (Full Rotary)	415.00	488.00	10/450
AC 2 041	8414	4 Step Fan Regulator (Full Rotary) NEW	365.00	425.00	10/300
ELECTRONIC DOOR BELL 240V~ 50Hz 2 MODULE					
AC 2 082	8531	Electronic Bell	360.00	399.00	10/300
AC 2 049	8531	Electronic Parrot Bell	234.00	258.00	10/300
STEP MARKER 240V~ 50Hz 2 MODULE					
AC 2 060	9405	Step Marker Light (LED-White)	470.00	549.00	10/300
AC 2 060	9405	Step Marker Light (LED-Warm White)	470.00	549.00	10/300
AC 2 060	9405	Step Marker Light (LED-Blue)	470.00	549.00	10/300
STEP MARKER 240V~ 50Hz 3 MODULE					
AC 3 061	9405	Step Marker Light (LED-White)	527.00	613.00	10/300
AC 3 061	9405	Step Marker Light (LED-Warm White)	527.00	613.00	10/300
AC 3 061	9405	Step Marker Light (LED-Blue)	527.00	613.00	10/300
NIGHT LAMP 240V~ 50Hz 2 MODULE					
AC 2 062	9405	Popup Night Lamp - advance LED light on/off system (LED-White)	490.00	570.00	5/100
AC 2 062	9405	Popup Night Lamp - advance LED light on/off system (LED-Warm White)	490.00	570.00	5/100
AC 2 062	9405	Popup Night Lamp - advance LED light on/off system (LED-Blue)	490.00	570.00	5/100



AC 1 034 AC 2 035 AC 2 036



AC 1 039 AC 2 040 AC 2 041

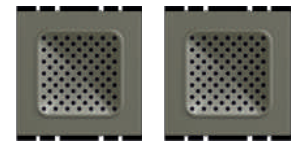

AC 2 082 AC 2 049



AC 2 060 - WH AC 2 060 - WW



AC 2 060 - BL



AC 3 061 - WH AC 3 061 - WW



AC 3 061 - BL



AC 2 062 - WH AC 2 062 - WW



AC 2 062 - BL



AC 2 053



AC 2 054



AC 1 050



AC 2 074



AC 2 108



AC 4 148-WH

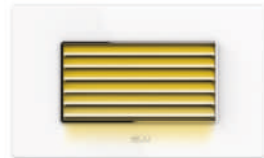

AC 4 148-WW



AC 4 148-BL

CODE	HSN CODE	ITEM	MRP ₹		STD./MST. PKG.
			GLOSSY WHITE	GRAPHITE MAGNESIA TITANIUM SILVER	
DND / MAKE MY ROOM UNIT 240V~ 50Hz 2 MODULE					
AC 2 053	8536	Do Not Disturb / Make My Room Indicator Unit (Outside Room)	504.00	578.00	10/300
AC 2 054	8536	Do Not Disturb / Make My Room Actuator Unit (Inside Room) with door bell circuit.	551.00	636.00	10/300
BELL INDICATOR DISPLAY UNIT 240V~ 50Hz 1 MODULE					
AC 1 050	8536	Bell Indicator Display Unit reset switch & name plate.	301.00	349.00	10/300
HOTEL KEY FOB SWITCH & KEY FOB 2 MODULE					
AC 2 074	8536	32Amp DP Switch with indicator (LED) operated by key FOB, 240V~ (Key FOB included)	428.00	552.00	10/300
AC 2 108	8538	Key FOB with name plate for product AC 2 074	101.00	118.00	20/800
FLOOR AND STEP LIGHT - 4 MODULE					
AC 4 148 WH	8538	Moonlite (White LED) Fully recessed floor & step light with support frame & cover plate, 240V~ 50-60Hz	790.00	869.00	5/50
AC 4 148 WW	8538	Moonlite (Warm White LED) Fully recessed floor & step light with support frame & cover plate, 240V~ 50-60Hz	790.00	869.00	5/50
AC 4 148 BL	8538	Moonlite (Blue LED) Fully recessed floor & step light with support frame & cover plate, 240V~ 50-60Hz	790.00	869.00	5/50

CODE	HSN CODE	ITEM	MRP ₹		STD./MST. PKG.
			GLOSSY WHITE	GRAPHITE MAGNESIA TITANIUM SILVER	
SINGLE POLE MCBs 240V~ 50Hz 1 MODULE					
AC 1 110	8536	C6 SP MCB*	286.00	338.00	10/300
AC 1 111	8536	C10 SP MCB*	286.00	338.00	10/300
AC 1 112	8536	C16 SP MCB*	286.00	338.00	10/300
AC 1 113	8536	C20 SP MCB*	286.00	338.00	10/300
AC 1 114	8536	C25 SP MCB*	286.00	338.00	10/300
AC 1 115	8536	C32 SP MCB*	286.00	338.00	10/300
		*Breaking Capacity 3kA			
DOUBLE POLE MCBs 240V~ 50Hz 2 MODULE					
AC 2 116	8536	C6 DP MCB*	591.00	697.00	10/200
AC 2 117	8536	C10 DP MCB*	591.00	697.00	10/200
AC 2 118	8536	C16 DP MCB*	591.00	697.00	10/200
AC 2 119	8536	C20 DP MCB*	591.00	697.00	10/200
AC 2 120	8536	C25 DP MCB*	591.00	697.00	10/200
AC 2 121	8536	C32 DP MCB*	591.00	697.00	10/200
		*Breaking Capacity 3kA			
MOTOR STARTER SWITCHES (SINGLE PHASE) 240V~ 2 MODULE					
AC 2 138	8536	16Amp Motor Starter Switch	542.00	639.00	10/200
AC 2 139	8536	20Amp Motor Starter Switch	542.00	639.00	10/200
AC 2 140	8536	25Amp Motor Starter Switch	542.00	639.00	10/200
AC 2 141	8536	32Amp Motor Starter Switch	542.00	639.00	10/200
UNIVERSAL USB CHARGERS 240V~ 50Hz 1 & 2 MODULE					
AC 1 167	8504	USB Charger 2USB ports, Output - 5V DC, 2.1A	1124.00	1240.00	5/100
AC 2 453	8504	USB Charger with Indicator (LED) 4USB ports, Output - 5V DC, 4.2A	1642.00	1887.00	5/100



AC 1 110 AC 1 111 AC 1 112



AC 1 113 AC 1 114 AC 1 115



AC 2 116 AC 2 117 AC 2 118



AC 2 119 AC 2 120 AC 2 121



AC 2 138 AC 2 139



AC 2 140 AC 2 141

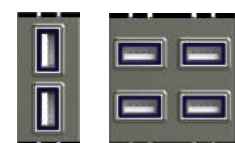

AC 1 167 AC 2 453

X2 - COVER PLATES (with support frame)

MODULES →	1M	2M	3M	3M*	4M**(H&V)	4M	6M**(H&V)	6M*
HSN CODE	8538	8538	8538	8538	8538	8538	8538	8538
PLATES ↓	MRP ₹	MRP ₹	MRP ₹	MRP ₹	MRP ₹	MRP ₹	MRP ₹	MRP ₹
PURE GLOSSY	FHSQ 01 001 83.00	FHSQ 02 002 83.00	FHSQ 03 003 111.00	FHSQ 03 010 111.00	FHSQ 04 004 138.00	FHSQ 04 013 138.00	FHSQ 06 005 188.00	FHSQ 06 011 206.00
GLOSSY	FESQ 01 001 83.00	FESQ 02 002 83.00	FESQ 03 003 111.00	FESQ 03 010 111.00	FESQ 04 004 138.00	FESQ 04 013 138.00	FESQ 06 005 188.00	FESQ 06 011 206.00
METALIK	FFSQ 01 001 120.00	FESQ 02 002 120.00	FESQ 03 003 161.00	FESQ 03 010 161.00	FESQ 04 004 200.00	FESQ 04 013 200.00	FESQ 06 005 272.00	FESQ 06 011 298.00
WOOD	FGSQ 01 001 157.00	FGSQ 02 002 157.00	FGSQ 03 003 211.00	FGSQ 03 010 211.00	FGSQ 04 004 262.00	FGSQ 04 013 262.00	FGSQ 06 005 356.00	FGSQ 06 011 391.00
STD./MST PKG.	20/400	20/400	20/400	20/400	20/400	20/400	10/200	10/200
SIZE (mm)	98 x 91	98 x 91	120 x 91	124 x 91	151 x 91	151 x 91	222 x 91	219 x 91

X2 - COVER PLATES (Dimensions in mm)



8M**(H&V)	8M*	8M (V)	12M	16M**(H&V)	18M
8538	8538	8538	8538	8538	8538
MRP ₹	MRP ₹	MRP ₹	MRP ₹	MRP ₹	MRP ₹
FHSQ 08 006 258.00	FHSQ 08 012 286.00	FHSQ 08 007 258.00	FHSQ 12 008 296.00	FHSQ 16 014 317.00	FHSQ 18 009 419.00
FESQ 08 006 258.00	FESQ 08 012 286.00	FESQ 08 007 258.00	FESQ 12 008 296.00	FESQ 16 014 317.00	FESQ 18 009 419.00
FFSQ 08 006 373.00	FFSQ 08 012 415.00	FFSQ 08 007 373.00	FFSQ 12 008 429.00	FFSQ 16 014 460.00	FFSQ 18 009 607.00
FGSQ 08 006 489.00	FGSQ 08 012 544.00	FGSQ 08 007 489.00	FGSQ 12 008 562.00	FGSQ 16 014 602.00	FGSQ 18 009 796.00
10/200	10/200	10/160	10/120	10/80	10/80
275 x 91	245 x 91	158 x 165	225 x 162	275 x 162	225 x 230

X2 - SUPPORT FRAMES - Horizontal & Vertical for Fixing (Dimensions in mm)

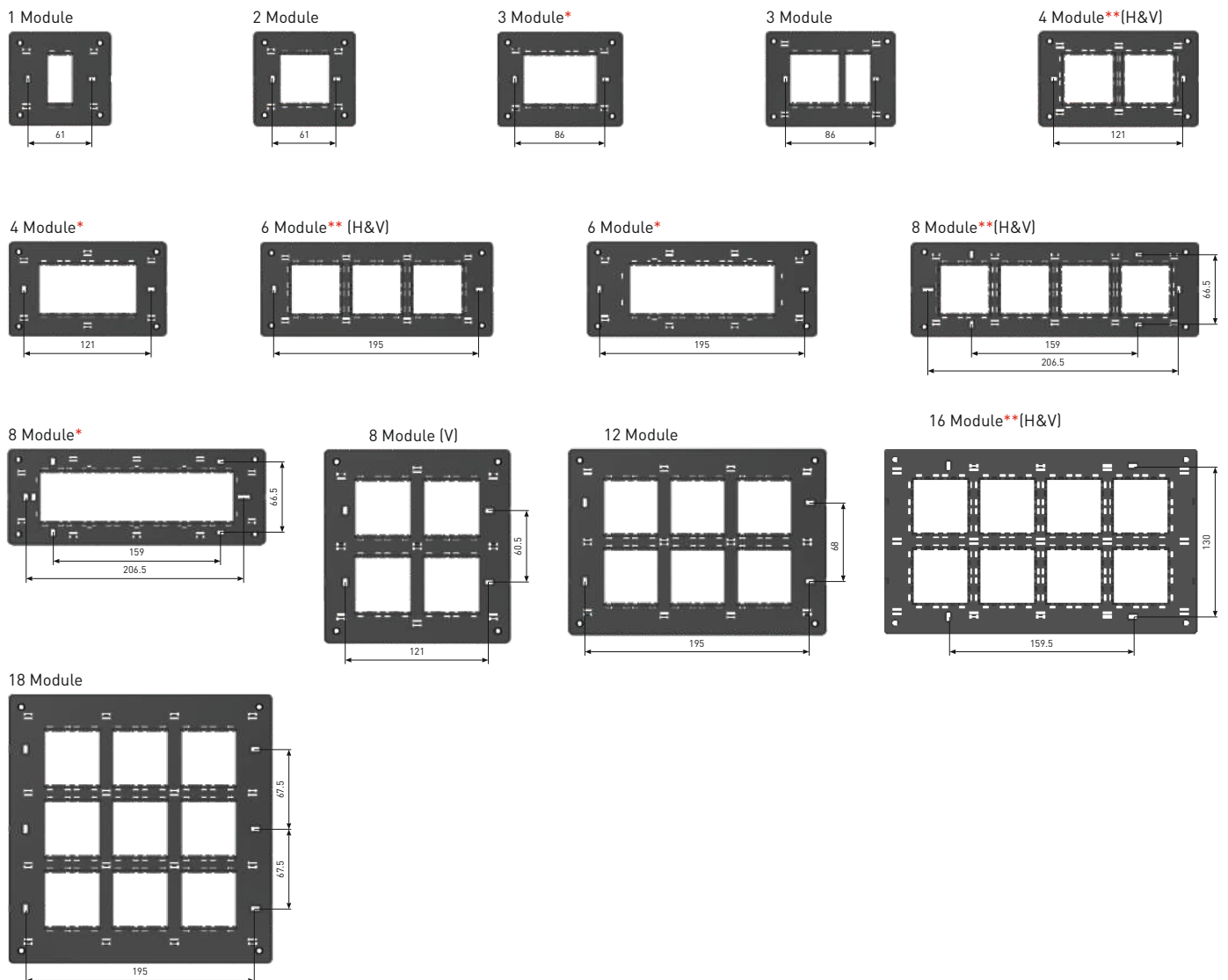

*Without Partition

**Suitable for Horizontal & Vertical Fittings

X3 - COVER PLATES (with support frame) - Suitable for wooden and metal box

MODULES	1M	2M	3M	4M	4M**(H&V)	4M*	6M	6M**(H&V)	8M
HSN CODE	8538	8538	8538	8538	8538	8538	8538	8538	8538
PLATES	MRP ₹	MRP ₹	MRP ₹	MRP ₹	MRP ₹	MRP ₹	MRP ₹	MRP ₹	MRP ₹
PURE GLOSSY	FLSR 01 001 94.00	FLSR 02 002 94.00	FLSR 03 003 118.00	FLSR 04 004 161.00	FLSR 04 014 161.00	FLSR 04 016 161.00	FLSR 06 005 225.00	FLSR 06 015 225.00	FLSR 08 006 266.00
GLOSSY	FISR 01 001 94.00	FISR 02 002 94.00	FISR 03 003 118.00	FISR 04 004 161.00	FISR 04 014 161.00	FISR 04 016 161.00	FISR 06 005 225.00	FISR 06 015 225.00	FISR 08 006 266.00
METALIK	FJSR 01 001 142.00	FJSR 02 002 142.00	FJSR 03 003 180.00	FJSR 04 004 255.00	FJSR 04 014 255.00	FJSR 04 016 255.00	FJSR 06 005 340.00	FJSR 06 015 340.00	FJSR 08 006 406.00
WOOD	FKSR 01 001 179.00	FKSR 02 002 179.00	FKSR 03 003 226.00	FKSR 04 004 322.00	FKSR 04 014 322.00	FKSR 04 016 322.00	FKSR 06 005 423.00	FKSR 06 015 423.00	FKSR 08 006 509.00
STD./MST PKG.	20/400	20/400	20/400	20/300	20/300	20/300	10/200	10/200	10/200
SIZE (inch)	4.5 x 4.5	4.5 x 4.5	4.5 x 5.0	4.5 x 6.5	4.5 x 7.5	4.5 x 6.5	4.5 x 8.5	4.5 x 8.5	4.5 x 10.5

X3 - COVER PLATES (Dimensions in inch) - Suitable for wooden and metal box

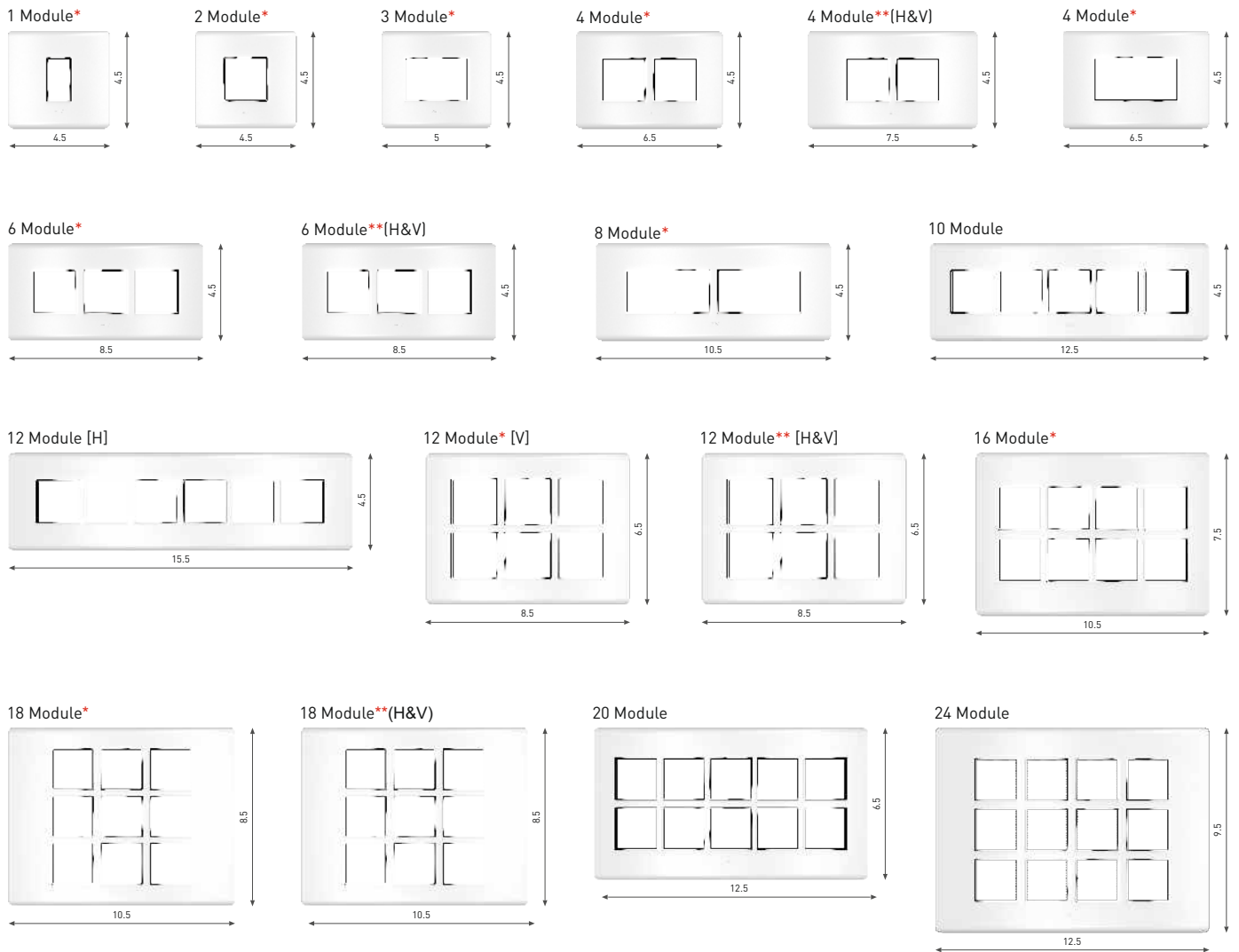

10M	12M (H)	12M (V)	12M** (H&V)	16M	18M	18M** (H&V)	20M	24M
8538	8538	8538	8538	8538	8538	8538	8538	8538
MRP ₹	MRP ₹	MRP ₹	MRP ₹	MRP ₹	MRP ₹	MRP ₹	MRP ₹	MRP ₹
FLSR 10 007 310.00	FLSR 12 008 351.00	FLSR 12 009 385.00	FLSR 12 017 385.00	FLSR 16 010 405.00	FLSR 18 011 449.00	FLSR 18 018 449.00	FLSR 20 012 563.00	FLSR 24 013 701.00
FISR 10 007 310.00	FISR 12 008 351.00	FISR 12 009 385.00	FISR 12 017 385.00	FISR 16 010 405.00	FISR 18 011 449.00	FISR 18 018 449.00	FISR 20 012 563.00	FISR 24 013 701.00
FJSR 10 007 471.00	FJSR 12 008 534.00	FJSR 12 009 586.00	FJSR 12 017 586.00	FJSR 16 010 610.00	FJSR 18 011 683.00	FJSR 18 018 683.00	FJSR 20 012 858.00	FJSR 24 013 1059.00
FKSR 10 007 588.00	FKSR 12 008 667.00	FKSR 12 009 732.00	FKSR 12 017 732.00	FKSR 16 010 763.00	FKSR 18 011 853.00	FKSR 18 018 853.00	FKSR 20 012 1071.00	FKSR 24 013 1330.00
10/150	10/120	10/120	10/120	10/90	10/80	10/80	10/80	10/80
4.5 x 12.5	4.5 x 15.5	6.5 x 8.5	6.5 x 8.5	6.5/7.5 x 10.5	8.5 x 10.5	8.5 x 10.5	6.5 x 12.5	9.5 x 12.5

X3 - SUPPORT FRAMES - Horizontal & Vertical for Fixing [Dimensions in mm]

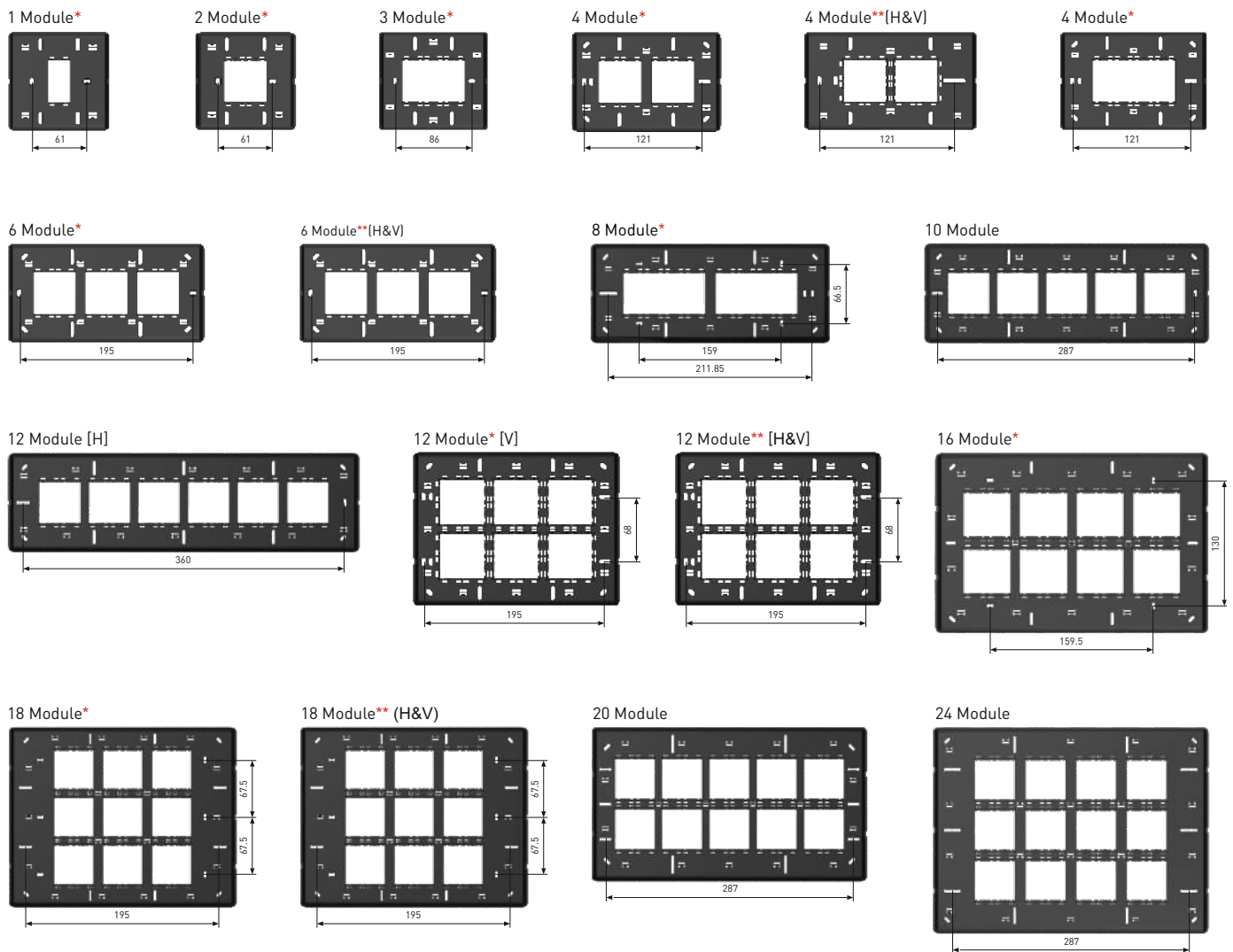

*Suitable for Metal Box

**Suitable for Horizontal & Vertical Fittings

FLUSH MOUNTING METAL GANG BOX (Galvanised)

MODULES →	1&2M	3M	4M	6M	8M(H)	8M(V)	12M	16M	18M
HSN CODE	8538	8538	8538	8538	8538	8538	8538	8538	8538
GANG BOX ↓	MRP ₹	MRP ₹	MRP ₹	MRP ₹	MRP ₹	MRP ₹	MRP ₹	MRP ₹	MRP ₹
	CM 02 001 63.00	CM 03 002 84.00	CM 04 003 101.00	CM 06 004 123.00	CM 08 005 164.00	CM 08 006 164.00	CM 12 008 221.00	CM 16 009 268.00	CM 18 010 309.00
STD./MST PKG.	10/120	10/120	10/120	5/80	5/60	5/60	5/45	5/45	5/40
SIZE (inch)	77x75x50	102x75x52	137x75x52	210x75x52	232x75x52	137x132x61	211x132x61	232x146x61	211x202x61



1&2 Module



3 Module



4 Module



6 Module



8 Module (H)



8 Module (V)



12 Module



16 Module



18 Module

X2 COVER PLATES

PURE GLOSSY



Glossy White

GLOSSY



Glossy White

METALIK

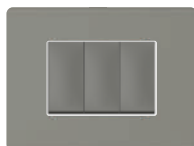

Graphite Magnesia



Titanium Silver

WOOD



Wenge

X2

X3 COVER PLATES

PURE GLOSSY



Glossy White

GLOSSY



Glossy White

METALIK



Graphite Magnesia



Titanium Silver

X3

WOOD



Wenge





It's time for some revolution

SMART SWITCHES

The G-Nine range of switches & accessories are inspired by good design and innovative ideas that emphasize the quality of a product. We sincerely believe your home should tell the story of who you are and what you love. In a progressive world, our tastes keep on changing. And it is very important to stay in touch with the trend. With a little revolution in the things we use, we are progressive moving ahead with the moving world.

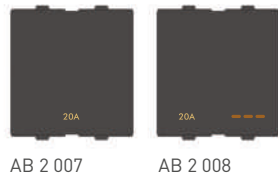
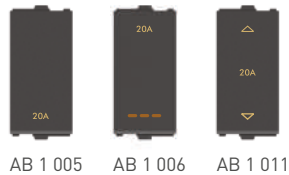
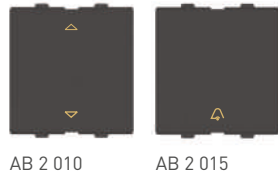
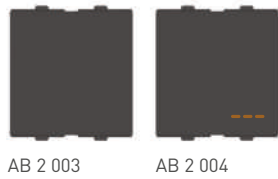
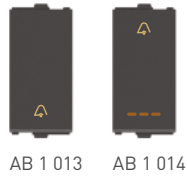
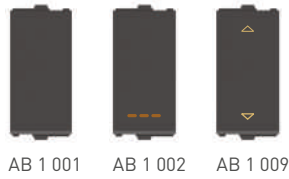

CODE	HSN CODE	ITEM	MRP ₹		
			GLOSSY WHITE	GRAPHITE MAGNESIA	STD./ MST. PKG.
VIVA 10AX SWITCHES 240V~ 1 MODULE					
AB 1 001	8536	1 Way Switch	62.00	72.00	20/600
AB 1 002	8536	1 Way Switch with Indicator (LED)	116.00	133.00	20/600
AB 1 009	8536	2 Way Switch	116.00	133.00	20/600
AB 1 013	8536	Bell Push Switch	126.00	145.00	20/600
AB 1 014	8536	Bell Push Switch with Indicator (LED)	143.00	163.00	20/600
VIVA 10AX SWITCHES 240V~ 2 MODULE					
AB 2 003	8536	1 Way Switch	137.00	156.00	10/300
AB 2 004	8536	1 Way Switch with Indicator (LED)	153.00	175.00	10/300
AB 2 010	8536	2 Way Switch	170.00	196.00	10/300
AB 2 015	8536	Bell Push Switch	160.00	184.00	10/300
AB 2 016	8536	Bell Push Switch with Indicator (LED)	178.00	206.00	10/300
VIVA 20AMP SWITCHES 240V~ 1 MODULE					
AB 1 005	8536	1 Way Switch	155.00	178.00	20/600
AB 1 006	8536	1 Way Switch with Indicator (LED)	173.00	199.00	20/600
AB 1 011	8536	2 Way Switch	173.00	199.00	20/600
VIVA 20AMP SWITCHES 240V~ 2 MODULE					
AB 2 007	8536	1 Way Switch	189.00	217.00	10/300
AB 2 008	8536	1 Way Switch with Indicator (LED)	210.00	242.00	10/300
AB 2 012	8536	2 Way Switch	218.00	252.00	10/300
VIVA 32AMP DP SWITCHES 240V~ 2 MODULE					
AB 2 024	8536	DP Switch with Indicator (LED)	315.00	361.00	10/300
AB 2 159	8536	DP Switch with Indicator (LED)	396.00	455.00	10/300

CODE	HSN CODE	ITEM	MRP ₹		
			GLOSSY WHITE	GRAPHITE MAGNESIA	STD./MST. PKG.
GENIA 6AX SWITCHES 240V~ 1 MODULE					
AB 1 201	8536	1 Way Switch	51.00	61.00	20/600
AB 1 202	8536	1 Way Switch with Indicator (LED)	111.00	127.00	20/600
AB 1 209	8536	2 Way Switch	111.00	127.00	20/600
AB 1 213	8536	Bell Push Switch	120.00	139.00	20/600
AB 1 214	8536	Bell Push Switch with Indicator (LED)	141.00	161.00	20/600
GENIA 6AX SWITCHES 240V~ 2 MODULE					
AB 2 203	8536	1 Way Switch	128.00	147.00	10/300
AB 2 204	8536	1 Way Switch with Indicator (LED)	145.00	167.00	10/300
AB 2 210	8536	2 Way Switch	145.00	167.00	10/300
AB 2 215	8536	Bell Push Switch	154.00	176.00	10/300
AB 2 216	8536	Bell Push Switch with Indicator (LED)	172.00	197.00	10/300
GENIA 16AX SWITCHES 240V~ 1 MODULE					
AB 1 205	8536	1 Way Switch	147.00	170.00	20/600
AB 1 206	8536	1 Way Switch with Indicator (LED)	165.00	190.00	20/600
AB 1 211	8536	2 Way Switch	165.00	190.00	20/600
GENIA 16AX SWITCHES 240V~ 2 MODULE					
AB 2 207	8536	1 Way Switch	176.00	202.00	10/300
AB 2 208	8536	1 Way Switch with Indicator (LED)	195.00	225.00	10/300
AB 2 212	8536	2 Way Switch	195.00	225.00	10/300
GENIA 32AMP DP SWITCH 240V~ 2 MODULE					
AB 2 224	8536	DP Switch with Indicator (LED)	306.00	354.00	10/300

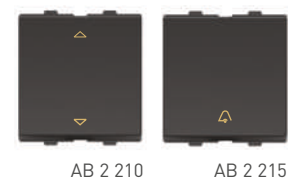
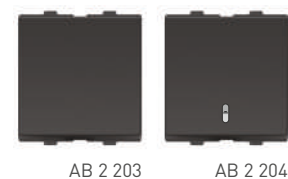
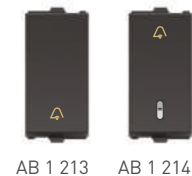
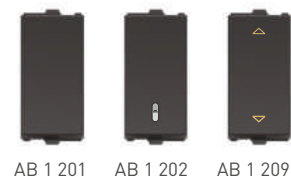



YOUR HOME BECOMES AN EXEMPLAR

An idea that converts into a style. A style that becomes your standard. A standard that defines your living. Design that speaks of your uniqueness and becomes a complete solution for your home décor. The fascinating taste within G-Nine lets you be as special as your individuality.

CODE	HSN CODE	ITEM	MRP ₹		
			GLOSSY WHITE	GRAPHITE MAGNESIA	STD./MST. PKG.
JAVA 6/10AX SWITCHES 240V~ 1 MODULE					
AB 1 301	8536	1 Way Switch	68.00	78.00	20/600
AB 1 302	8536	1 Way Switch with Indicator (LED)	123.00	142.00	20/600
AB 1 303	8536	2 Way Switch	123.00	142.00	20/600
AB 1 304	8536	Bell Push Switch	131.00	153.00	20/600
AB 1 305	8536	Bell Push Switch with Indicator (LED)	152.00	173.00	20/600
JAVA 6/10AX SWITCHES 240V~ 2 MODULE					
AB 2 306	8536	1 Way Switch	143.00	165.00	10/300
AB 2 307	8536	1 Way Switch with Indicator (LED)	160.00	184.00	10/300
AB 2 308	8536	2 Way Switch	178.00	206.00	10/300
AB 2 309	8536	Bell Push Switch	171.00	197.00	10/300
AB 2 310	8536	Bell Push Switch with Indicator (LED)	188.00	216.00	10/300
JAVA 20AMP SWITCHES 240V~ 1 MODULE					
AB 1 311	8536	1 Way Switch	162.00	188.00	20/600
AB 1 312	8536	1 Way Switch with Indicator (LED)	183.00	210.00	20/600
AB 1 313	8536	2 Way Switch	183.00	210.00	20/600
JAVA 20AMP SWITCHES 240V~ 2 MODULE					
AB 2 314	8536	1 Way Switch	201.00	232.00	10/300
AB 2 315	8536	1 Way Switch with Indicator (LED)	220.00	255.00	10/300
AB 2 316	8536	2 Way Switch	232.00	268.00	10/300
JAVA DP SWITCHES 240V~ 2 MODULE					
AB 2 317	8536	20A DP Switch with Indicator (LED)	286.00	329.00	10/300
AB 2 318	8536	32A DP Switch with Indicator (LED)	400.00	458.00	10/300
JAVA BLANK PLATE - 1 MODULE					
AB 1 319	8538	Blank Plate	26.00	29.00	50/1500





AB 1 026 AB 1 027 AB 1 088

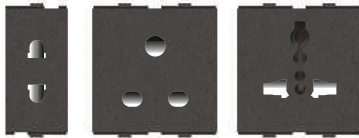

AB 1 028 AB 2 029 AB 2 030



AB 2 135 AB 2 136

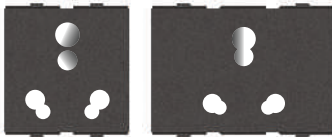

AB 2 031 AB 3 132



AB 2 142 AB 2 160

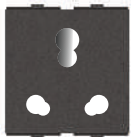

AB 2 137



AB 1 032 AB 1 043 AB 1 044 AB 1 045



AB 1 046 AB 1 047



AB 1 145 AB 2 144 AB 1 146

CODE	HSN CODE	ITEM	MRP ₹		
			GLOSSY WHITE	GRAPHITE MAGNESIA	STD./ MST. PKG.
INDICATOR, FUSE UNITS 240V~ 1 MODULE					
AB 1 026	8536	Indicator with neon bulb holder	102.00	113.00	20/600
AB 1 027	8536	Fuse 10Amp with glass tube ϕ 6.3 x 28	143.00	159.00	20/600
AB 1 088	8536	Fuse 15Amp with glass tube ϕ 6.3 x 28	149.00	172.00	20/600
6AMP / 10AMP / 13AMP SOCKETS 240V~					
AB 1 028	8536	6Amp 2 Pin Euro-American Socket-1M - with safety shutter	96.00	109.00	20/600
AB 2 029	8536	10Amp Combined Socket - 2M - with safety shutter	122.00	140.00	10/300
AB 2 030	8536	13Amp International Socket - 2M - with safety shutter	190.00	213.00	10/300
AB 2 135	8536	10Amp Universal Socket 2/3 Pin - 2M - with mobile charger socket & safety shutter	123.00	143.00	10/300
AB 2 136	8536	6Amp 2 in 1 Socket - 2M - with safety shutter	108.00	122.00	10/300
6 & 16AMP / 25AMP SOCKETS 240V~					
AB 2 031	8536	6 & 16Amp Universal Socket - 2M - with safety shutter	208.00	243.00	10/300
AB 3 132	8536	6 & 16Amp Universal Socket - 3M - with safety shutter	253.00	290.00	10/300
AB 2 142	8536	6 & 16Amp Universal Socket - 2M - with safety shutter	208.00	243.00	10/300
AB 2 160	8536	6 & 16Amp Universal Raised Socket- 2M - with safety shutter	228.00	263.00	10/300
AB 2 137	8536	6 & 25Amp Universal Socket - 2M - with safety shutter	248.00	285.00	10/300
TV SOCKET / RJ-11 TEL JACKS - 1 MODULE					
AB 1 032	8536	TV Socket (Coaxial 40-862 MHz Socket)	116.00	137.00	20/600
AB 1 043	8536	2 Line Jack, RJ-11 with shutter	124.00	142.00	20/600
AB 1 044	8536	2 Line Jack, RJ-11 with PCB	114.00	131.00	20/600
AB 1 045	8536	4 Line Jack, RJ-11 with PCB	152.00	173.00	20/600
EDP SOCKETS - 1 MODULE					
AB 1 046	8536	EDP Socket Outlet - RJ 45 (Cat 5e)*	244.00	281.00	20/600
AB 1 047	8536	EDP Socket Outlet - RJ 45 (Cat 6)* *with shutter & insulation - piercing terminal	571.00	657.00	20/600
AUDIO - VIDEO SOCKETS					
AB 1 145	8536	Triple RCA Socket (Audio & Video) - 1M	754.00	867.00	20/600
AB 2 144	8536	HDMI Socket - 2M	975.00	1121.00	10/300
AB 1 146	8536	Female HD15 (VGA) - 1M	360.00	413.00	20/600

CODE	HSN CODE	ITEM	MRP ₹		
			GLOSSY WHITE	GRAPHITE MAGNESIA	STD./MST. PKG.
DIMMERS 240~ 50-60Hz					
AB 1 020	8533	Dimmer - 300Watt - 1M	255.00	294.00	10/450
AB 2 021	8533	Dimmer - 300Watt - 2M	336.00	386.00	10/300
AB 2 022	8533	Dimmer - 600Watt - 2M	472.00	543.00	10/300
AB 1 034	8533	Dimmer - 300Watt - 1M	254.00	292.00	10/450
AB 2 035	8533	Dimmer - 300Watt - 2M	329.00	379.00	10/300
AB 2 037	8533	Dimmer - 600Watt - 2M	470.00	541.00	10/300
STEP FAN REGULATORS 240~ 50-60Hz					
AB 1 033	8414	4 Step - Fan Regulator - 100Watt - 1M (Full Rotary)	375.00	432.00	10/450
AB 2 041	8414	5 Step - Fan Regulator - 100Watt - 2M (Full Rotary)	419.00	482.00	10/300
AB 1 039	8414	4 Step - Fan Regulator - 100Watt - 1M (Full Rotary)	375.00	432.00	10/450
AB 2 040	8414	5 Step - Fan Regulator - 100Watt - 2M (Full Rotary)	419.00	482.00	10/300
ELECTRONIC DOOR BELL - 2 MODULE 240~ 50-60Hz					
AB 2 082	8531	Electronic Parrot Bell	195.00	225.00	10/300
ELECTRONIC BUZZER - 2 MODULE 240~ 50-60Hz					
AB 2 049	8531	Electronic Buzzer	183.00	210.00	10/300
LIGHT FITTINGS					
AB 2 060	9405	Light Fitting - 2M with 5 Directional Light & LED, 240V~ 50-60Hz	501.00	577.00	10/200
AB 2 061	9405	Light Fitting - 2M with 5 Directional Light & Design Glass, LED, 240V~ 50-60Hz	525.00	603.00	10/200
AB 3 063	9405	Light Fitting - 3M with High Efficiency LED, 3 Step Dimming Switch, ON/OFF Switch, 240V~ 50-60Hz	1171.00	1346.00	5/100
EMERGENCY LIGHT - 3 MODULE					
AB 3 058	9405	Emergency Light Fitting - 3M with high luminous LED, 3 steps dimming & ON/OFF Switch, 240V~ 50-60Hz, automatic emergency device, rechargeable & replaceable battery (BL-5C Li-ion Battery, 3.7V, 1050mAh) *Battery included.	1601.00	1839.00	5/100



AB 1 020 AB 2 021



AB 1 034 AB 2 035



AB 1 033 AB 2 041



AB 1 039 AB 2 040



AB 2 082



AB 2 049



AB 2 060 AB 2 061



AB 3 063

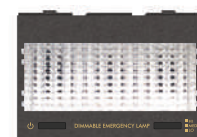

AB 3 058



AB 1 052



AB 2 109



AB 2 053



AB 2 054



AB 1 050



AB 2 074



AB 2 108



AB 3 075



AB 3 075 GA



AB 3 076



AB 2 143

CODE	HSN CODE	ITEM	MRP ₹		
			GLOSSY WHITE	GRAPHITE MAGNESIA	STD./ MST. PKG.
BLANK PLATE - 1 MODULE					
AB 1 052	8538	Blank Plate	26.00	29.00	50/1500
PASSIVE INFRARED SENSOR (MOVEMENT DETECTOR) - 2 MODULE					
AB 2 109	8536	Passive Infrared Sensor - 2M with integral relay, three modes - day, night & direct load bypass with time delay function, 450W - 240V~ 50-60Hz	1458.00	1569.00	5/100
DND / MAKE MY ROOM UNIT - 2 MODULE					
AB 2 053	8536	Do Not Disturb / Make My Room Indicator Unit with Bell Push (Outside Room), 240V~ 50-60Hz	504.00	578.00	10/300
AB 2 054	8536	Do Not Disturb / Make My Room Actuator Unit (Inside Room) with door bell circuit, 240V~ 50-60Hz	551.00	636.00	10/300
BELL INDICATOR DISPLAY UNIT - 1 MODULE					
AB 1 050	8536	Bell Indicator Display Unit with reset switch & name plate, 240V~ 50-60Hz	301.00	347.00	10/600
HOTEL KEY FOB SWITCH AND KEY FOB					
AB 2 074	8536	32Amp DP Switch - 2M with indicator (LED) operated by key FOB, 240V~ (Key FOB included)	532.00	613.00	5/200
AB 2 108	8536	Key FOB with name plate for product AB 2 074	113.00	130.00	20/800
AB 3 075	8536	20Amp Smart Card Operated Electronic Switch - 3M with indicator (LED) & integral relay having exit delay, 240V~ 50-60Hz	1542.00	1776.00	5/100
AB 3 075 -GA	8536	Smart Card customizable for product AB 3 075*	129.00	-	20/1000
SHAVER SOCKET - 3 MODULE					
AB 3 076	8536	Shaver Socket (Euro American) with isolating transformer, 240V~ 50-60Hz, Output 110/240V~	1367.00	1574.00	5/100
SIGNAGE - 2 MODULE					
AB 2 143	9405	LED Signage Customizable, 240V~ 50-60Hz	488.00	529.00	10/200

CODE	HSN CODE	ITEM	MRP ₹		
			GLOSSY WHITE	GRAPHITE MAGNESIA	STD./MST. PKG.
FLOOR AND STEP LIGHTS - 4 MODULE 240V~ 50-60Hz					
AB 4 148 WH	9405	Accent Light with LED White*	785.00	903.00	5/50
AB 4 148 WW	9405	Accent Light with LED Warm White*	785.00	903.00	5/50
AB 4 148 BL	9405	Accent Light with LED Blue*	785.00	903.00	5/50
AB 4 149 WH	9405	Accent Light with LED White**	725.00	833.00	5/50
AB 4 149 WW	9405	Accent Light with LED Warm White**	725.00	833.00	5/50
AB 4 149 BL	9405	Accent Light with LED Blue**	725.00	833.00	5/50
		** Fully recessed floor & step light			
MOTOR STARTER SWITCHES (SINGLE PHASE) 240V~ 2 MODULE					
AB 2 138	8536	16Amp Motor Starter Switch	647.00	742.00	10/200
AB 2 139	8536	20Amp Motor Starter Switch	647.00	742.00	10/200
AB 2 140	8536	25Amp Motor Starter Switch	647.00	742.00	10/200
AB 2 141	8536	32Amp Motor Starter Switch	647.00	742.00	10/200
SINGLE POLE MCBs 240V~, - 50-60Hz - 1 MODULE					
AB 1 110	8536	C6 SP MCB*	298.00	342.00	10/300
AB 1 111	8536	C10 SP MCB*	298.00	342.00	10/300
AB 1 112	8536	C16 SP MCB*	298.00	342.00	10/300
AB 1 113	8536	C20 SP MCB*	298.00	342.00	10/300
AB 1 114	8536	C25 SP MCB*	298.00	342.00	10/300
AB 1 115	8536	C32 SP MCB*	298.00	342.00	10/300
		*Breaking Capacity 3kA			



AB 4 148 WH

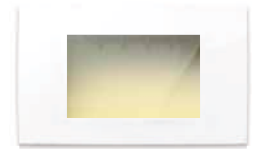

AB 4 148 WW

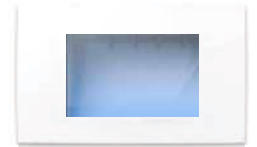

AB 4 148 BL



AB 4 149 WH



AB 4 149 WW



AB 4 149 BL



AB 2 138



AB 2 139



AB 2 140



AB 2 141



AB 1 110



AB 1 111



AB 1 112



AB 1 113



AB 1 114



AB 1 115



AB 2 116 AB 2 117 AB 2 118



AB 2 119 AB 2 120 AB 2 121



AB 1 147 AB 1 150



AB 2 453



AB 3 454



AB 2 090



AB 2 091

CODE	HSN CODE	ITEM	MRP ₹		
			GLOSSY WHITE	GRAPHITE MAGNESIA	STD./ MST. PKG.
DOUBLE POLE MCBs 240V~, - 50-60Hz - 2 MODULE					
AB 2 116	8536	C6 DP MCB*	601.00	689.00	10/200
AB 2 117	8536	C10 DP MCB*	601.00	689.00	10/200
AB 2 118	8536	C16 DP MCB*	601.00	689.00	10/200
AB 2 119	8536	C20 DP MCB*	601.00	689.00	10/200
AB 2 120	8536	C25 DP MCB*	601.00	689.00	10/200
AB 2 121	8536	C32 DP MCB*	601.00	689.00	10/200
*Breaking Capacity 3kA					
USB CHARGERS					
AB 1 147	8504	USB Charger - 1M with indicator (LED), Input - 240V~ 50-60Hz, Output - 5V DC, 2.1A	943.00	1049.00	5/100
AB 1 150	8504	USB Charger - 1M with indicator (LED) & 2 USB ports, Input - 240V~ 50-60Hz, Output - 5V DC, 2.6A	1124.00	1240.00	5/100
AB 2 453	8504	USB Charger - 2M with indicator (LED) & 2 USB ports, Input - 240V~ 50-60Hz, Output - 5V DC, 2.1A	1230.00	1355.00	5/100
AB 3 454	8504	USB Charger & 13Amp International Socket - 3M with indicator (LED) & 2 USB ports, Input - 240V~ 50-60Hz, Output - 5V DC, 2.1A	1420.00	1560.00	5/100
BLUETOOTH MUSIC SYSTEM / STEREOPHONIC SPEAKER - 2 MODULE					
AB 2 090	8518	Bluetooth Music System Input - 240V~ 50-60Hz, Capacitive Touch Buttons, Audio Output - 2 Speaker out 3W each*, Bluetooth stereo connectivity to any Bluetooth enabled device. Advanced LED indication. Can be connected to external ceiling or in-wall speaker through amplifier. (Amplifier not included) *AB 2 091 stereophonic speaker not included	4000.00	4400.00	1/100
AB 2 091	8518	Stereophonic Speaker 2 pcs. Output - 3W each	1299.00	1399.00	1/50

CODE	HSN CODE	ITEM	MRP ₹		
			GLOSSY WHITE	GRAPHITE MAGNESIA	STD./MST. PKG.
TOUCH SWITCH - 1 MODULE					
AB 1 401	8536	Touch - 1 Switch* 110 - 240V~ 6A. *Can also be operated by IR transmitter AB 1 411 and remote controller - AB R 003	935.00	1075.00	5/100
TOUCH DIMMER - 1 MODULE					
AB 1 402	8533	Touch - Dimmer* 110 - 240V~ 450Watt *Can also be operated by IR transmitter AB 1 411 and remote controller - AB R 003	1015.00	1167.00	5/100
TOUCH REGULATOR - 2 MODULE					
AB 2 403	8414	Touch - 5 Step Fan Regulator* 110 - 240V~ 100Watt *Can also be operated by IR transmitter AB 1 411 and remote controller - AB R 003	2130.00	2450.00	5/100
TOUCH INFRARED TRANSMITTER - 1 MODULE					
AB 1 411	8536	Touch - IR Transmitter* 110 - 240V~ *Can also be operated by IR transmitter AB 1 411 and remote controller - AB R 003	575.00	665.00	5/100
TOUCH INFRARED REMOTE					
AB R 003	8536	Touch - Infrared Remote Control 3x7 channels, 2 nos. CR 2032 3V Battery (Battery included)	1099.00	—	5/100



AB 1 401



AB 1 402



AB 2 403



AB 1 411



AB R 003

1 Switch

- Rated Voltage - 110-240V~ • Rated Load
- a) Resistive 6A. b) Incandescent Lamp - 1000W.
- c) Halogen with Transformer - 700W.
- d) Halogen without Transformer - 1000W.
- e) Compact Fluorescent Lamp - 300W.
- f) Inductive Motor Load (power factor 0.6 lag) 1.8A.

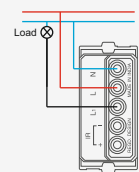

Dimmer

- Rated Voltage - 110-240V~ 50Hz
- Rated Load - 450W
- 9 Stage for Level of Intensity of Light
- Tested for 20,000 Switching Cycles at Rated Voltage and Rated Load
- Low Internal Power Loss Giving Rise to Minimum Temperature Rise
- Working Principle - Dimmer Triac Base

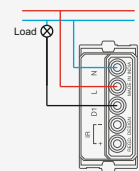

5 Step Fan Regulator

- Rated Voltage - 110-240V~ 50Hz
- Rated Load - 100W
- Tested for 20,000 Switching Cycles at Rated Voltage and Rated Load
- Low Internal Power Loss Giving Rise to Minimum Temperature Rise

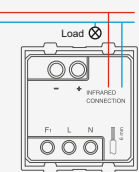
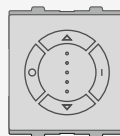

Infrared Transmitter

- Rated Voltage - 110-240V~ 50Hz
- IR Receiver

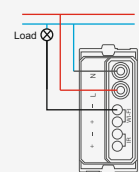





Distinction in reputation.

COVER PLATES

X-Pulse has pleasing finishes in glossy, metallic and wood. The switch plates are well-suited for a good design reputation and the gently risen contours in the center become a visible and distinctive factor of the switch plate. Add the charm of an individualistic design of the X-Pulse and live the joy of a good lifestyle.

X-PLANA - COVER PLATES (with Support Frame)

MODULES →	1M	2M	3M	3M*	4M	6M
HSN CODE	8538	8538	8538	8538	8538	8538
PLATES ↓	MRP ₹	MRP ₹	MRP ₹	MRP ₹	MRP ₹	MRP ₹
GLOSSY	GPA SD 01 001 85.00	GPA SD 02 002 85.00	GPA SD 03 003 112.00	GPA SD 03 009 112.00	GPA SD 04 004 135.00	GPA SD 06 005 193.00
METALIK	GPB SD 01 001 134.00	GPB SD 02 002 134.00	GPB SD 03 003 177.00	GPB SD 03 009 177.00	GPB SD 04 004 211.00	GPB SD 06 005 273.00
WOOD	GPC SD 01 001 180.00	GPC SD 02 002 180.00	GPC SD 03 003 225.00	GPC SD 03 009 225.00	GPC SD 04 004 271.00	GPC SD 06 005 363.00
STD./MST PKG.	20/400	20/400	20/400	20/400	20/400	10/200
SIZE (mm)	93 x 87	93 x 87	116 x 87	116 x 87	151 x 87	223 x 87

X-PLANA - COVER PLATES (Dimensions in mm)



* Without Partition

8M (H)	8M*	8M (V)	12M	16M	18M
8538	8538	8538	8538	8538	8538
MRP ₹	MRP ₹	MRP ₹	MRP ₹	MRP ₹	MRP ₹
GPA SD 08 006 252.00	GPA SD 08 011 252.00	GPA SD 08 012 252.00	GPA SD 12 007 282.00	GPA SD 16 008 307.00	GPA SD 18 010 354.00
GPB SD 08 006 363.00	GPB SD 08 011 363.00	GPB SD 08 012 363.00	GPB SD 12 007 439.00	GPB SD 16 008 474.00	GPB SD 18 010 493.00
GPC SD 08 006 509.00	GPC SD 08 011 509.00	GPC SD 08 012 509.00	GPC SD 12 007 567.00	GPC SD 16 008 655.00	GPC SD 18 010 706.00
10/200	10/200	10/180	10/120	10/80	10/120
281 x 87	244 x 87	151 x 165	223 x 160	281 x 160	223 x 225

X-PLANA - SUPPORT FRAMES (Dimensions in mm)

1/2 Module

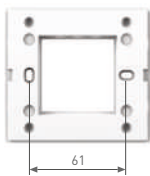

3 Module

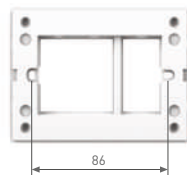

3 Module*

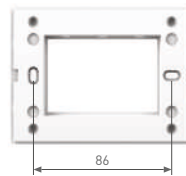

4 Module

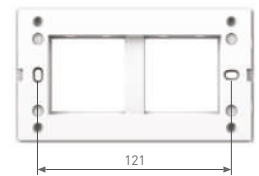

6 Module

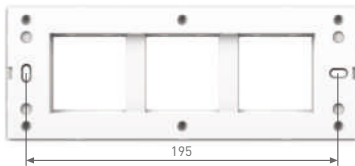

8 Module

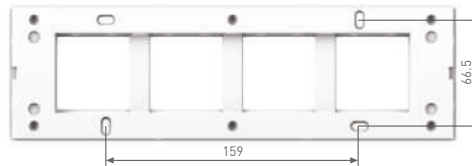

8 Module*

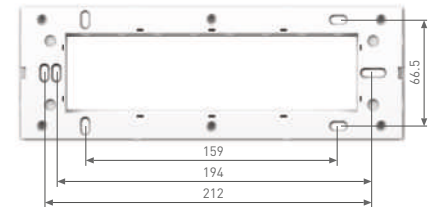

8 Module (V)

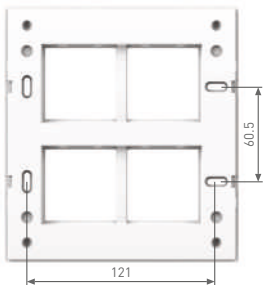

12 Module

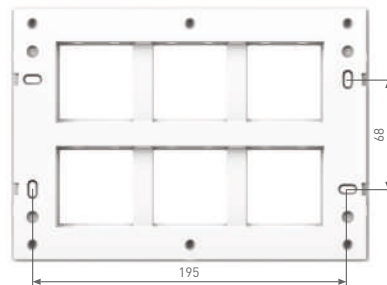

16 Module

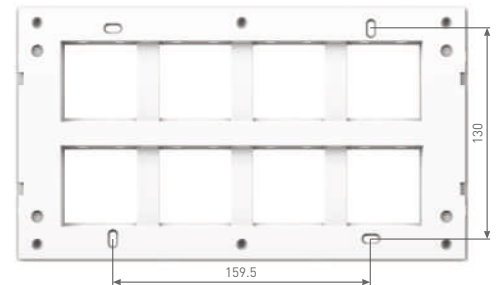

18 Module

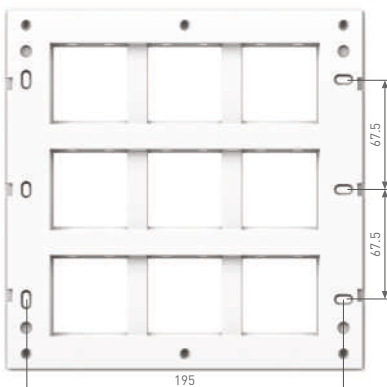

X-PULSE - COVER PLATES (with Support Frame)

MODULES →	1M	2M	3M	3M*	4M	6M
HSN CODE	8538	8538	8538	8538	8538	8538
PLATES ↓	MRP ₹	MRP ₹	MRP ₹	MRP ₹	MRP ₹	MRP ₹
PURE GLOSSY	GPR SE 01 001 89.00	GPR SE 02 002 89.00	GPR SE 03 003 116.00	GPR SE 03 004 116.00	GPR SE 04 005 142.00	GPR SE 06 006 205.00
GLOSSY	GPE SE 01 001 89.00	GPE SE 02 002 89.00	GPE SE 03 003 116.00	GPE SE 03 004 116.00	GPE SE 04 005 142.00	GPE SE 06 006 205.00
METALIK	GPF SE 01 001 144.00	GPF SE 02 002 144.00	GPF SE 03 003 189.00	GPF SE 03 004 189.00	GPF SE 04 005 217.00	GPF SE 06 006 292.00
WOOD	GPG SE 01 001 189.00	GPG SE 02 002 189.00	GPG SE 03 003 233.00	GPG SE 03 004 233.00	GPG SE 04 005 283.00	GPG SE 06 006 384.00
STD./MST PKG.	20/400	20/400	20/400	20/400	20/400	10/200
SIZE (mm)	92 x 88	92 x 88	127 x 88	120 x 88	150 x 88	222 x 88

X-PULSE - COVER PLATES (Dimensions in mm)



8M* NEW	8M	8M (V)	9M	12M	16M	18M
8538	8538	8538	8538	8538	8538	8538
MRP ₹	MRP ₹	MRP ₹	MRP ₹	MRP ₹	MRP ₹	MRP ₹
GPR SE 08 007 265.00	GPR SE 08 008 265.00	GPR SE 08 009 265.00	GPR SE 09 010 282.00	GPR SE 12 011 298.00	GPR SE 16 012 323.00	GPR SE 18 013 372.00
GPE SE 08 007 265.00	GPE SE 08 008 265.00	GPE SE 08 009 265.00	GPE SE 09 010 282.00	GPE SE 12 011 298.00	GPE SE 16 012 323.00	GPE SE 18 013 372.00
GPF SE 08 007 377.00	GPF SE 08 008 377.00	GPF SE 08 009 377.00	GPF SE 09 010 420.00	GPF SE 12 011 449.00	GPF SE 16 012 492.00	GPF SE 18 013 507.00
GPG SE 08 007 524.00	GPG SE 08 008 524.00	GPG SE 08 009 524.00	GPG SE 09 010 571.00	GPG SE 12 011 591.00	GPG SE 16 012 674.00	GPG SE 18 013 731.00
10/200	10/200	10/180	10/200	10/120	10/80	10/120
253 x 88	273 x 88	150 x 165	295 x 88	222 x 160	273 x 160	222 x 224

X-PULSE - SUPPORT FRAMES (Dimensions in mm)

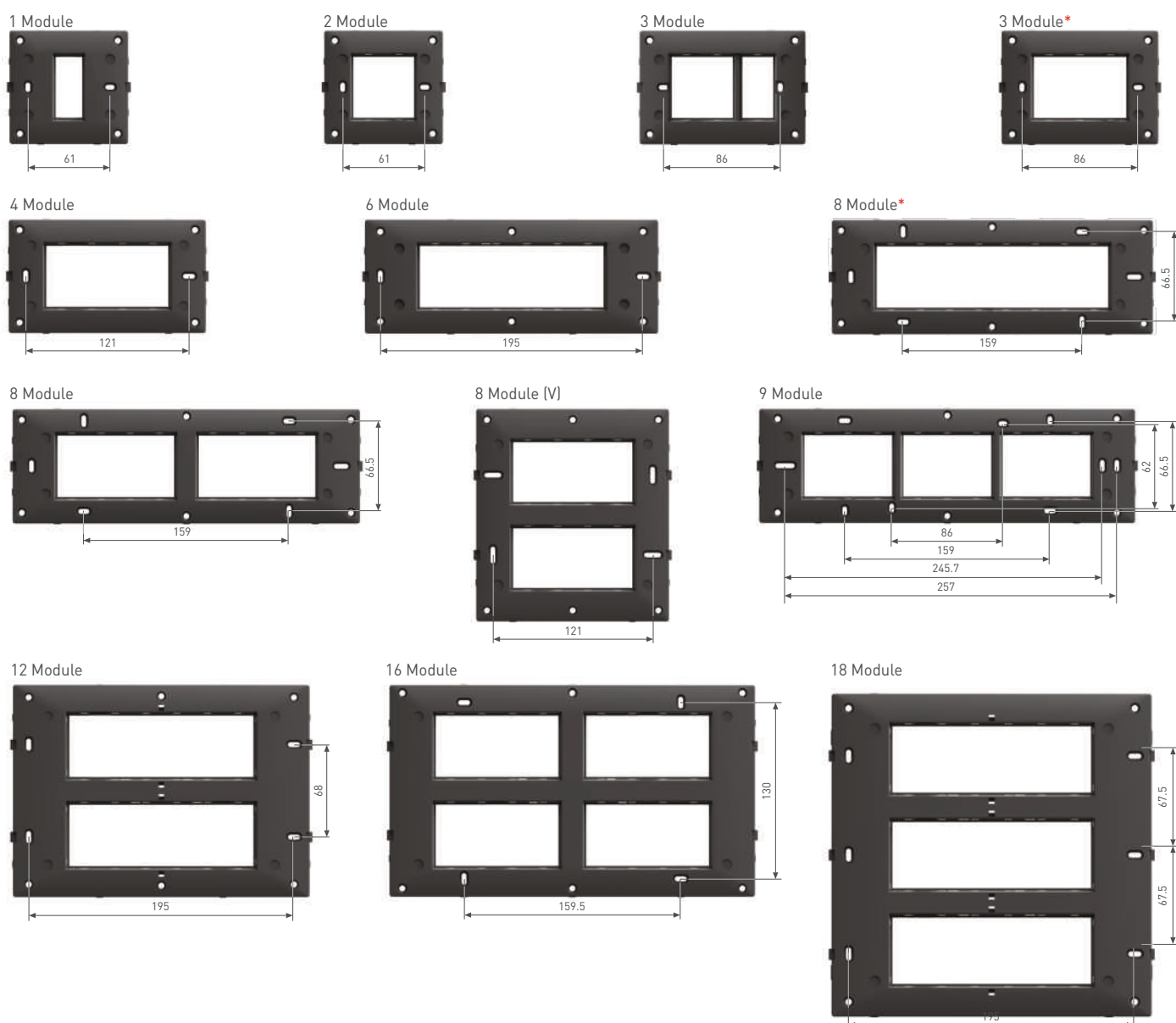

X-BRILLO - COVER PLATES (with Support Frame)

MODULES	1M	2M	3M	4M	6M	
HSN CODE	8538	8538	8538	8538	8538	
PLATES	MRP ₹	MRP ₹	MRP ₹	MRP ₹	MRP ₹	
METALIK BORDER	GLOSSY	GPM SJ 01 001 178.00	GPM SJ 02 002 178.00	GPM SJ 03 003 218.00	GPM SJ 04 004 267.00	GPM SJ 06 005 329.00
	METALIK	GPD SJ 01 001 258.00	GPD SJ 02 002 258.00	GPD SJ 03 003 287.00	GPD SJ 04 004 337.00	GPD SJ 06 005 399.00
	WOOD	GPI SJ 01 001 296.00	GPI SJ 02 002 296.00	GPI SJ 03 003 328.00	GPI SJ 04 004 409.00	GPI SJ 06 005 457.00
	GLASZ	GPH SJ 01 001 468.00	GPH SJ 02 002 468.00	GPH SJ 03 003 658.00	GPH SJ 04 004 870.00	GPH SJ 06 005 1143.00
NEW GRAPHITE MAGNESIA BORDER	GLOSSY	GPM SJ 01 001 M 178.00	GPM SJ 02 002 M 178.00	GPM SJ 03 003 M 218.00	GPM SJ 04 004 M 267.00	GPM SJ 06 005 M 329.00
	METALIK	GPD SJ 01 001 M 258.00	GPD SJ 02 002 M 258.00	GPD SJ 03 003 M 287.00	GPD SJ 04 004 M 337.00	GPD SJ 06 005 M 399.00
	WOOD	GPI SJ 01 001 M 296.00	GPI SJ 02 002 M 296.00	GPI SJ 03 003 M 328.00	GPI SJ 04 004 M 409.00	GPI SJ 06 005 M 457.00
	GLASZ	GPH SJ 01 001 M 468.00	GPH SJ 02 002 M 468.00	GPH SJ 03 003 M 658.00	GPH SJ 04 004 M 870.00	GPH SJ 06 005 M 1143.00
STD./MST PKG.	10/300	10/300	10/300	10/300	5/150	
SIZE (mm)	93x93	93x93	125x93	151x93	225x93	

X-BRILLO - COVER PLATES (Dimensions in mm)

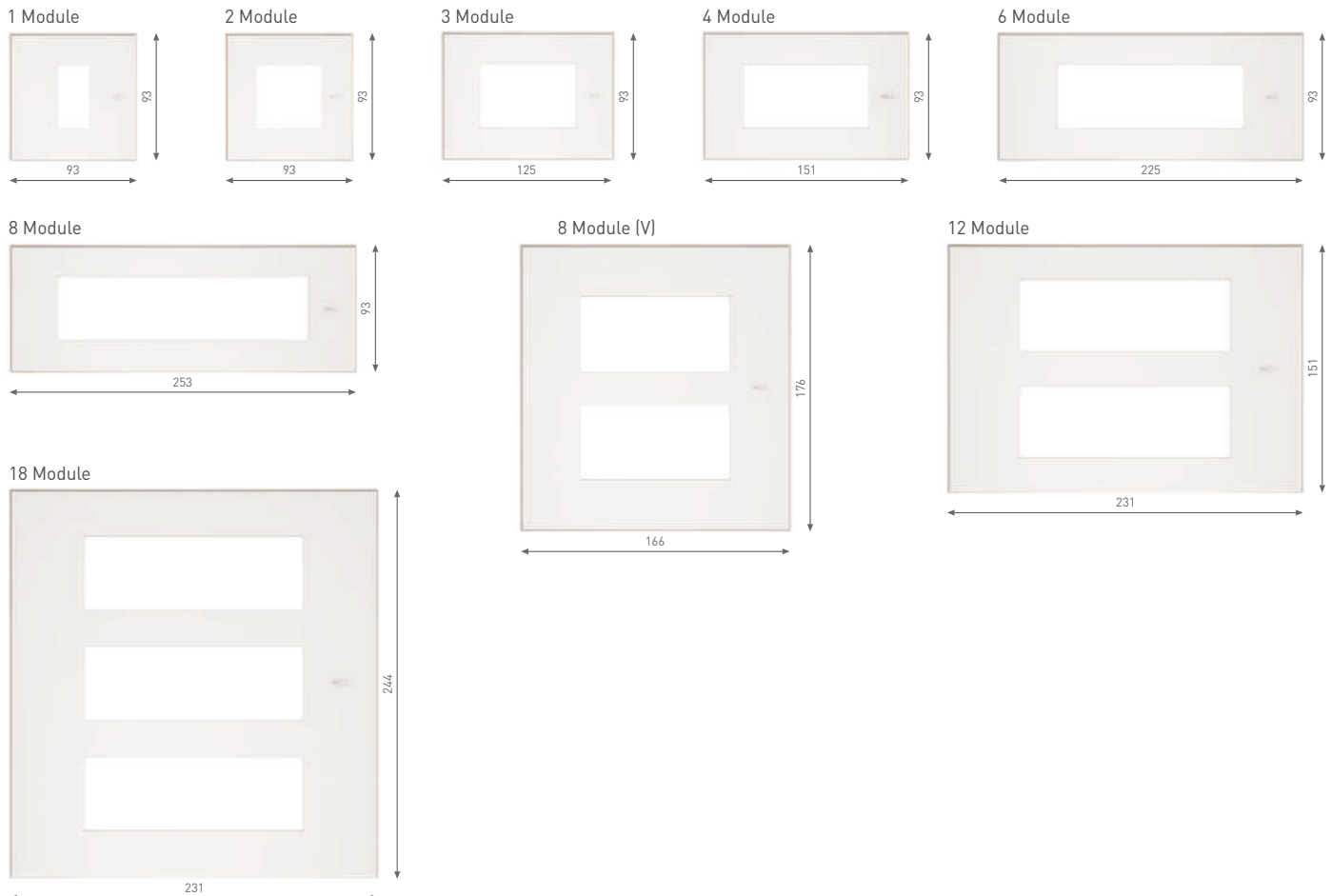

8M	8M (V)	12M	18M	
8538	8538	8538	8538	
MRP ₹	MRP ₹	MRP ₹	MRP ₹	
GPM SJ 08 006 426.00	GPM SJ 08 009 426.00	GPM SJ 12 010 567.00	GPM SJ 18 011 762.00	
GPD SJ 08 006 515.00	GPD SJ 08 009 515.00	GPD SJ 12 010 699.00	GPD SJ 18 011 875.00	
GPI SJ 08 006 591.00	GPI SJ 08 009 591.00	GPI SJ 12 010 800.00	GPI SJ 18 011 1064.00	
GPH SJ 08 006 1350.00	GPH SJ 08 009 1350.00	GPH SJ 12 010 1635.00	GPH SJ 18 011 1919.00	
GPM SJ 08 006 M 426.00	GPM SJ 08 009 M 426.00	GPM SJ 12 010 M 567.00	GPM SJ 18 011 M 762.00	
GPD SJ 08 006 M 515.00	GPD SJ 08 009 M 515.00	GPD SJ 12 010 M 699.00	GPD SJ 18 011 M 875.00	
GPI SJ 08 006 M 591.00	GPI SJ 08 009 M 591.00	GPI SJ 12 010 M 800.00	GPI SJ 18 011 M 1064.00	
GPH SJ 08 006 M 1350.00	GPH SJ 08 009 M 1350.00	GPH SJ 12 010 M 1635.00	GPH SJ 18 011 M 1919.00	
5/150	5/150	5/50	5/50	
253x93	166x176	231x161	231x244	

X-BRILLO - SUPPORT FRAMES (Dimensions in mm)

1/2 Module



3 Module

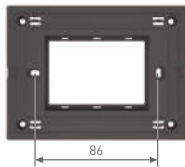

4 Module

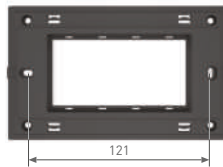

6 Module

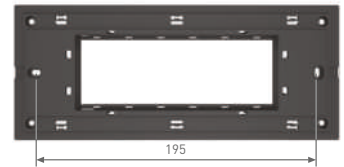

8 Module

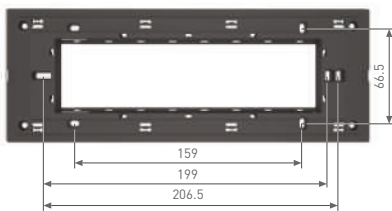

8 Module (V)

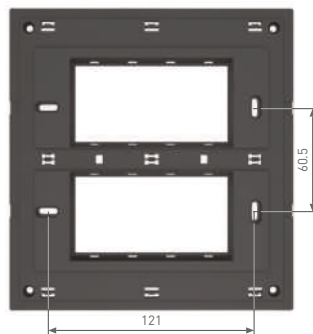

12 Module

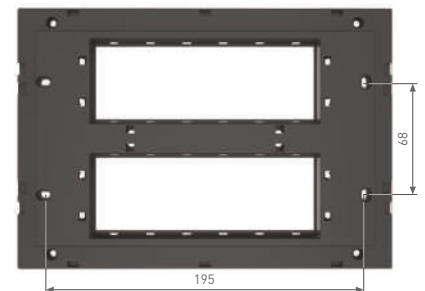

18 Module

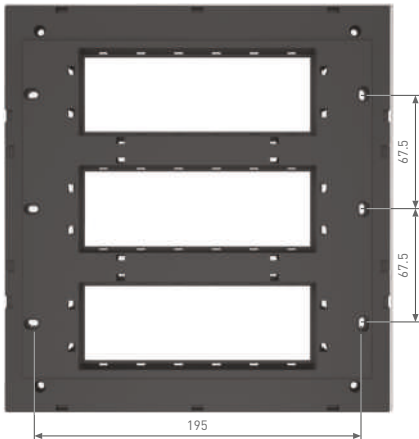

X-NOA - COVER PLATES (with Support Frame)

SUITABLE FOR WOODEN & METAL BOX

MODULES	1M*	2M*	3M*	4M*	4M*	6M*	8M*	10M
HSN CODE	8538	8538	8538	8538	8538	8538	8538	8538
PLATES	MRP ₹	MRP ₹	MRP ₹	MRP ₹	MRP ₹	MRP ₹	MRP ₹	MRP ₹
PURE GLOSSY	GPN SK 01 001 92.00	GPN SK 02 002 92.00	GPN SK 03 003 117.00	GPN SK 04 004 159.00	GPN SK 04 016 159.00	GPN SK 06 005 201.00	GPN SK 08 006 265.00	GPN SK 10 008 301.00
GLOSSY	GPQ SK 01 001 92.00	GPQ SK 02 002 92.00	GPQ SK 03 003 117.00	GPQ SK 04 004 159.00	GPQ SK 04 016 159.00	GPQ SK 06 005 201.00	GPQ SK 08 006 265.00	GPQ SK 10 008 301.00
METALIK	GPO SK 01 001 142.00	GPO SK 02 002 142.00	GPO SK 03 003 178.00	GPO SK 04 004 225.00	GPO SK 04 016 225.00	GPO SK 06 005 296.00	GPO SK 08 006 377.00	GPO SK 10 008 425.00
WOOD	GPP SK 01 001 189.00	GPP SK 02 002 189.00	GPP SK 03 003 235.00	GPP SK 04 004 284.00	GPP SK 04 016 284.00	GPP SK 06 005 389.00	GPP SK 08 006 525.00	GPP SK 10 008 554.00
STD./MST PKG.	20/400	20/400	20/400	20/300	20/300	10/200	10/200	10/150
SIZE (Inches)	4.5 x 4.5	4.5 x 4.5	4.5 x 5.0	4.5 x 6.5	4.5 x 7.5	4.5 x 8.5	4.5 x 10.5	4.5 x 12.5

X-NOA - COVER PLATES (Dimensions in inches)

SUITABLE FOR WOODEN & METAL BOX



* Suitable for Metal Box

12 (M)	12M (V)*	12M (H&M)*	16M*	18M*	18M (H&M)*	20M	24M
8538	8538	8538	8538	8538	8538	8538	8538
MRP ₹	MRP ₹	MRP ₹	MRP ₹	MRP ₹	MRP ₹	MRP ₹	MRP ₹
GPN SK 12 009 318.00	GPN SK 12 010 318.00	GPN SK 12 011 318.00	GPN SK 16 012 342.00	GPN SK 18 013 403.00	GPN SK 18 017 403.00	GPN SK 20 014 469.00	GPN SK 24 015 576.00
GPQ SK 12 009 318.00	GPQ SK 12 010 318.00	GPQ SK 12 011 318.00	GPQ SK 16 012 342.00	GPQ SK 18 013 403.00	GPQ SK 18 017 403.00	GPQ SK 20 014 469.00	GPQ SK 24 008 576.00
GPO SK 12 009 466.00	GPO SK 12 010 466.00	GPO SK 12 011 466.00	GPO SK 16 012 501.00	GPO SK 18 013 537.00	GPO SK 18 017 537.00	GPO SK 20 014 631.00	GPO SK 24 015 755.00
GPP SK 12 009 606.00	GPP SK 12 010 606.00	GPP SK 12 011 606.00	GPP SK 16 012 677.00	GPP SK 18 013 738.00	GPP SK 18 017 738.00	GPP SK 20 014 819.00	GPP SK 24 015 926.00
10/120	10/120	10/120	10/120	10/120	10/120	10/120	10/80
4.5 x 15.5	6.5 x 8.5	6.5 x 8.5	6.5 / 7.5 x 10.5	8.5 x 10.5	8.5 x 10.5	6.5 x 12.5	9.5 x 12.5

X-NOA - SUPPORT FRAMES (Dimensions in mm)

SUITABLE FOR WOODEN & METAL BOX

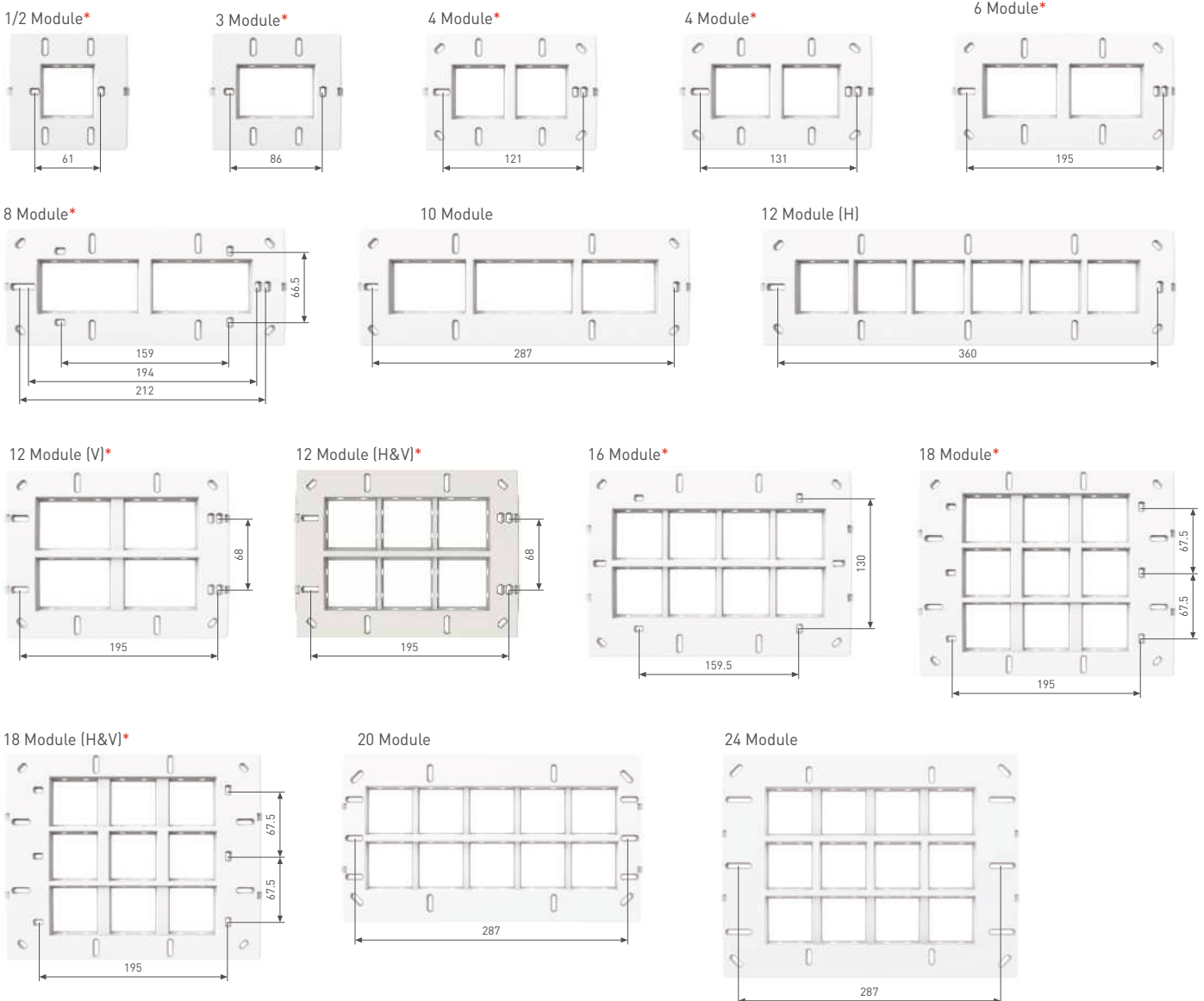

FLUSH MOUNTING METAL GANG BOX (Galvanised)

MODULE →	1 & 2M	3M	4M	6M	8M(H)	8M(V)	12M	16M	18M
HSN CODE	8538	8538	8538	8538	8538	8538	8538	8538	8538
GANG BOX ↓	MRP ₹	MRP ₹	MRP ₹	MRP ₹	MRP ₹	MRP ₹	MRP ₹	MRP ₹	MRP ₹
	LM 02 001 63.00	LM 03 002 84.00	LM 04 003 101.00	LM 06 004 123.00	LM 08 005 164.00	LM 08 006 164.00	LM 12 008 221.00	LM 16 009 268.00	LM 18 010 309.00
STD./MST.PKG.	10/120	10/120	10/120	5/80	5/60	5/60	5/45	5/45	5/40
SIZE (WxHxL) mm	77 x 75 x 50	102 x 75 x 50	137 x 75 x 52	210 x 75 x 52	232 x 75 x 52	137 x 132 x 61	211 x 132 x 61	232 x 146 x 61	211 x 202 x 61



1 & 2 Module



3 Module



4 Module



6 Module



8 Module (H)



8 Module (V)



12 Module



16 Module



18 Module

X Plana

GLOSSY



WHITE



BLACK

METALIK



GOLD



SILVER



GRAPHITE MAGNESIA

WOOD



CARBON WOOD



WALNUT



WENGE

X Pulse

PURE GLOSSY



WHITE

GLOSSY



WHITE



BLACK



RED

METALIK



GOLD



SILVER



GRAPHITE MAGNESIA



ROSE GOLD



BLACK GOLD

WOOD



CARBON WOOD



WALNUT



WENGE

METALIK BORDER



PURE GLOSSY



WHITE

GLOSSY



WHITE



BLACK



RED

METALIK



GOLD



SILVER



GRAPHITE MAGNESIA



ROSE GOLD

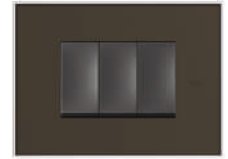

BLACK GOLD

WOOD



CARBON WOOD



WALNUT

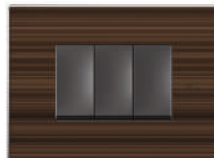

WENGE

GLASZ



WHITE



GREY



CHOCOLATE



RED



BLACK

GRAPHITE MAGNESIA BORDER NEW



GLOSSY



WHITE

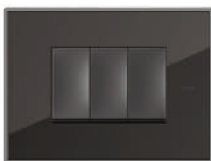

BLACK

METALIK



GOLD



SILVER



GRAPHITE MAGNESIA



ROSE GOLD



BLACK GOLD

WOOD



CARBON WOOD



WALNUT



WENGE

GLASZ



WHITE



GREY

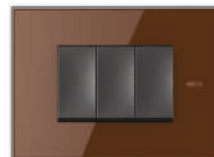

CHOCOLATE



RED



BLACK

PURE GLOSSY



PURE GLOSSY

GLOSSY



WHITE



BLACK



IVORY

METALIK



GOLD



SILVER



GRAPHITE MAGNESIA

WOOD



CARBON WOOD



WALNUT



WENGE



Simple Solutions for better homes.

MINI MODULARSWITCHES

Our mini-modular range of switches and accessories make life really simple. They are rightly designed keeping in mind the basic needs of every home. The values of quality, functionality and affordability are instilled in our products that assist you everyday.

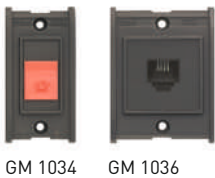
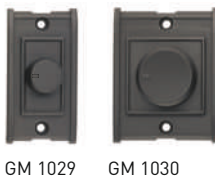

CODE	HSN CODE	ITEM	MRP ₹	STD./ MST. PKG.
10AX SWITCHES / INDICATOR				
GM 1001	8536	1 Way Switch	23.50	20/1200
GM 1002	8536	2 Way Switch	46.00	20/1200
GM 1003	8536	Bell Push	46.00	20/1200
GM 1004	8536	Indicator	46.00	20/1200
6 / 10 AMP. SOCKETS / 13 AMP. INTERNATIONAL SOCKET				
GM 1017	8536	6A 2 Pin Socket - with safety shutter	50.00	20/1200
GM 1018	8536	6A 2 Pin Socket - with safety shutter	50.00	20/1200
GM 1019	8536	10A 3 Pin Multi Socket - with safety shutter	56.00	10/600
GM 1020	8536	10A 2 In 1 Socket	52.00	10/600
GM 1021	8536	13A international socket	88.00	10/600
TV ANTENNA SOCKETS				
GM 1023	8536	Mini Tv Antenna Socket - With Cord-grip Configuration	65.00	20/1200
ELECTRONIC DIMMERS / REGULATORS				
GM 1026	8533	Mini Dimmer	214.00	10/500
GM 1027	8533	Medium Dimmer	232.00	10/300
GM 1029	8414	Electronic Type Mini 4 Step Fan Regulator (Full Rotary)	322.00	10/500
GM 1030	8414	Electronic Type 5 Step Fan Regulator (Full Rotary)	351.00	10/300
RJ-11 TELEPHONE JACKS / RJ-45 COMPUTER JACK				
GM 1034	8536	2 Line Tel Jack - with Enclosure	95.00	20/1200
GM 1036	8536	Rj-45 Computer Jack Category 6, universal wiring T568a, insulating piercing terminal	496.00	10/600
KITKAT FUSE				
GM 1039	8536	Kit-Kat Fuse Suitable for 10A. & 15A	85.00	10/600

CODE	HSN CODE	ITEM	MRP ₹	STD./ MST. PKG.
6A SWITCH SOCKET COMBINED				
GM 1042	8536	6A S.S Combined - with Indicator	112.00	10/300
GM 1043	8536	6A S.S Combined - with indicator & gang box	149.00	10/200
16AX SWITCHES				
GM 1044	8536	1 Way Switch	149.00	10/300
GM 1045	8536	2 Way Switch	176.00	10/300
16AX GAMA SWITCHES / 6 & 16 AMP UNIVERSAL SOCKET				
GM 1046	8536	Gama 1 Way Switch - with indicator	169.00	10/300
GM 1047	8536	Gama 2 Way Switch	209.00	10/300
GM 1048	8536	6 & 16Amp Universal Socket - with safety shutter	156.00	10/300
6 & 16 AMP 3 IN ONE				
GM 1050	8536	3 in one Universal S.S Combined - with safety shutter	285.00	5/150
GM 1049	8536	3 in one Universal S.S Combined - with safety shutter & gang box	331.00	5/150
6 & 16 AMP 5 IN ONE				
GM 1051	8536	5 in one Universal S.S Combined - with fuse, indicator & safety shutter	360.00	5/100
GM 1052	8536	5 in one Universal S.S Combined - with fuse, indicator, safety shutter & gang box	411.00	5/100
32 AMP DP SWITCH / 6A GAMA BELL PUSH				
GM 1053	8536	32Amp DP Switch - with indicator	266.00	10/300
GM 1054	8536	Gama Bell Push - with indicator	128.00	10/300



GM 1042



GM 1044

GM 1045



GM 1046

GM 1048



GM 1050



GM 1051



GM 1053

GM 1054



CODE	HSN CODE	ITEM	MRP ₹	STD./ MST. PKG.
G1 SWITCH COVER PLATES				
GM 1056	8538	Platinum	5.00	100/8000
GM 1057	8538	Silcol	8.00	100/8000
GM 1058	8538	Soft	8.50	100/8000
Suitable for 10AX. Switches, 6Amp. Ind. 2 Pin Sockets, Mini TV Antenna Socket, Blank Plate, Mini Dimmer, 4 Step Reg., 2 Line Tel Jack & Kit - Kat Fuse				
G2 SOCKET COVER PLATES				
GM 1061	8538	Platinum	6.50	100/6000
GM 1062	8538	Silcol	9.50	100/6000
GM 1063	8538	Soft	10.50	100/6000
Suitable for 10Amp. 3 Pin Multi Socket, 2 in One Socket, 2x1 International Soc. Med. TV Antenna Socket, Med. Dimmer, 5 Step Fan Reg., 4 line Tel Jack, RJ-45 Computer Jack, Buzzer & Night Lamp				
G7 S.S. COMBINED COVER PLATES				
GM 1180	8538	Platinum	29.00	50/1500
GM 1181	8538	Silcol	36.00	50/1500
GM 1182	8538	Soft	41.00	50/1500
Suitable for 6A S.S. Combined				
G3 SWITCH COVER PLATES				
GM 1066	8538	Platinum	20.00	50/3000
GM 1067	8538	Silcol	28.00	50/3000
GM 1068	8538	Soft	31.00	50/3000
Suitable for 16AX. Switches				
G4 SOCKET COVER PLATES				
GM 1071	8538	Platinum	23.00	50/2400
GM 1072	8538	Silcol	31.00	50/2400
GM 1073	8538	Soft	34.00	50/2400
Suitable for 6 & 16Amp. Socket, 32Amp. DP Switch, Gama 16AX Switch, & Gama Bell Push				
G5 3 IN ONE COVER PLATES				
GM 1076	8538	Platinum	33.00	25/1500
GM 1077	8538	Silcol	42.00	25/1500
GM 1078	8538	Soft	46.00	25/1500
Suitable for 16Amp. 3 in One				
G6 5 IN ONE COVER PLATES				
GM 1081	8538	Platinum	44.00	25/1200
GM 1082	8538	Silcol	58.00	25/1200
GM 1083	8538	Soft	67.00	25/1200
Suitable for 16Amp. 5 in One				
Available colours in Base: Graphite Grey, Snow White & Glass Green				

Revolutionary designs.

Amazing colours.

Available colours in cover plates:
 Platinum: White, Ivory Gold, Sand Grey, Glass Green
 Silcol: Gold, Titanium Silver, Copper, Turquoise Blue, Sage Green, Pearl, Pearl Gold, Pearl Green, Peacock Green, Silver Hue, Golden Olive, Graphite Magnesia & Black Gold
 Soft: Burgandy Double Colour, Aqua Blue Double Colour, Sea Green, Italian Wood, French Wood, African Wenge & Walnut

CODE	HSN CODE	ITEM	MRP ₹	STD./ MST. PKG.
FLUSH MOUNTING PLASTIC GANG BOXES				
GM 1095	8538	Switch / Socket	24.00	10/300
GM 1096	8538	16A 3 In One Suitable for 16A 3inOne	33.00	5/200
GM 1097	8538	16A 5 In One Suitable for 16A 5inOne	37.00	5/100
G-MET PLATES (Suitable for Modular Metal Boxes)				
GM 1100	8538	1 & 2 Module Plate	58.00	10/480
GM 1101	8538	3 Module Plate	79.00	10/480
GM 1102	8538	4 Module Plate	85.00	10/480
GM 1103	8538	6 Module Plate	123.00	10/240
GM 1104	8538	8 Module Plate	155.00	10/180
GM 1105	8538	8 Module Plate - Vertical	155.00	10/180
GM 1106	8538	12 Module Plate	198.00	5/180
GM 1107	8538	16 Module Plate	212.00	5/180
GM 1108	8538	18 Module Plate	230.00	5/180
G-WOOD PLATES (Suitable for Wooden Boxes)				
GM 1110	8538	4.5 X 4.5 Plate	50.00	10/480
GM 1111	8538	4.5 X 6.5 Plate	65.00	10/480
GM 1112	8538	4.5 X 8.5 Plate	91.00	10/240
GM 1113	8538	4.5 X 10.5 Plate	128.00	10/240
GM 1114	8538	4.5 X 12.5 Plate	134.00	10/240
GM 1115	8538	6.5 X 8.5 Plate	155.00	10/180
GM 1116	8538	7.5 X 10.5 Plate	226.00	10/180
GM 1117	8538	6.5 X 10.5 Plate	184.00	10/180
GM 1118	8538	6.5 X 12.5 Plate	208.00	10/180
GM 1158	8538	4.5 X 15.5 Plate	156.00	10/120
GM 1159	8538	8.5 X12.5 Plate	249.00	10/100
GM 1160	8538	10.5 X 12.5 Plate	255.00	10/100
GM 1173	8538	8.5 X10.5 Plate	238.00	10/120

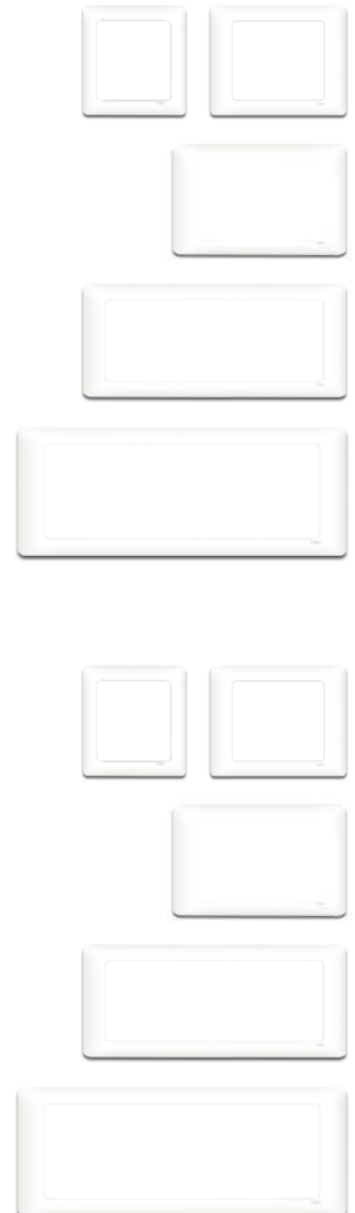
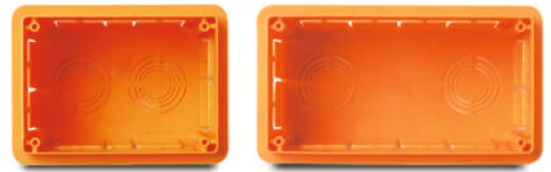



Undoubtedly the best travel companion.

TRAVEL ADAPTORS

Admit it, you have regretted traveling without one on your travels. They are indispensable travel companions wherever you go.



GM 3001 GM 3002 GM 3003 GM 3004



GM 3303 GM 3304 GM 3305 GM 3306



GM 3006 GM 3051 GM 3052 GM 3054



GM 3005 GM 3007 GM 3008 GM 3009



GM 3011 GM 3012 GM 3013



GM 3048 GM 3049 GM 3050



GM 3017 GM 3018

CODE	HSN CODE	ITEM	MRP ₹	STD./ MST. PKG.
PLUG TOPS				
GM 3001	8536	6 Amp Safe 3 Pin Plug Top	73.00	20/600
GM 3002	8536	16 Amp Safe 3 Pin Plug Top	91.00	10/300
GM 3003	8536	6 Amp Elite 3 Pin Plug Top	85.00	20/600
GM 3004	8536	16 Amp Elite 3 Pin Plug Top	95.00	10/300
GM 3303	8536	6 Amp Axton 3 Pin Plug Top *	88.00	20/600
GM 3304	8536	16 Amp Axton 3 Pin Plug Top *	103.00	10/300
GM 3305	8536	6 Amp Magnus 3 Pin Plug Top *	88.00	20/600
GM 3306	8536	16 Amp Magnus 3 Pin Plug Top *	103.00	10/300
		* with indicator		
MINI TRAVEL ADAPTORS / 2 PIN PLUGS				
GM 3006	8536	2 Pin Conversion Plug	26.00	20/640
GM 3051	8536	2 Pin Multi Plug Adaptor	53.00	20/600
GM 3052	8536	2 Pin Plug	30.00	20/1200
GM 3053	8536	2 Pin Female Socket	24.00	20/1200
GM 3054	8536	2 Pin Plug/socket	50.00	50/800
UNIVERSAL TRAVEL ADAPTORS				
GM 3005	8536	Mini 3 Pin Travel Universal Adaptor - suitable for all kinds of plugs used around the world	99.00	10/360
GM 3007	8536	2 Pin Travel Universal Adaptor - with surge protector & safety shutter	188.00	10/180
GM 3008	8536	3 Pin Travel Universal Adaptor - with surge protector & safety shutter	224.00	10/180
GM 3009	8536	2 Pin Square Travel Universal Adaptor - with indicator & safety shutter	218.00	10/180
GM 3011	8536	2 Pin Travel Universal Multi Plug - with surge protector & indicator	200.00	10/180
GM 3012	8536	3 Pin Travel Universal Multi Plug - with surge protector & indicator	249.00	10/180
GM 3013	8536	3 Pin Travel Universal Adaptor - suitable for 16A sockets with surge protector & safety shutter	237.00	10/180
GM 3048	8536	3 Pin Multi Plug Adaptor	132.00	10/180
GM 3049	8536	3 Pin Universal Adaptor - with indicator	127.00	10/180
GM 3050	8536	16amp 3 Pin Multi Plug Adaptor	204.00	10/120
GM 3017	8536	Spice 3 Pin Multiplug	132.00	10/120
GM 3018	8536	3 Pin Universal Travel Adaptor - master switch with 2 int. & 2 pin sockets with indicator	333.00	5/90

CODE	HSN CODE	ITEM	MRP ₹	STD/ MST. PKG.
USB / WORLD TRAVEL ADAPTORS				
GM 3010	8536	World Travel Adaptor	1040.00	5/90
GM 3222	8536	Atlas Universal Travel Adaptor - with 2.1A USB charger	989.00	5/60
		Available in 5 Colours. ● ● ● ● ●		
CUBA SERIES				
GM 3261	8537	Cuba 4+1 Power Strip master switch, indicator, safety shutter, 3 international sockets & 3 USB port 2.4A available in 2 colours. ○ ●	849.00	10/80
GM 3262	8537	Cuba 3+1 Power Strip master switch, indicator, safety shutter, 2 international sockets & 3 USB port 2.4A available in 2 colours. ○ ●	749.00	10/80
GM 3263	8537	PD Charger pd type C+QC 3.0 USB+5v2.4 A dual USB charger with timer charger	3199.00	5/100
GM 3264	8537	4 Port Usb Travel Charger Usb Charger 4 Port 2.4 A Available In 3 Colours. ○ ● ●	549.00	20/160



GM 3010



GM 3222



GM 3261



GM 3262



GM 3263



GM 3264



GM 3020 GM 3021 GM 3022 GM 3091



GM 3099 GM 3026 GM 3027 GM 3233



GM 3224 GM 3225



GM 3220 GM 3221 GM 3223



GM 3211 GM 3212



GM 3023 GM 3024 GM 3028 GM 3073 GM 3025



GM 1176 GM 1177 GM 1186 GM 1179

CODE	HSN CODE	ITEM	MRP ₹	STD./ MST. PKG.
LAMP HOLDERS				
GM 3020	8536	Angle Holder	49.00	20/400
GM 3021	8536	Batten Holder	49.00	20/400
GM 3022	8536	Jumbo Batten Holder	60.00	20/400
GM 3091	8536	Uno Angle Holder *	55.00	20/400
GM 3099	8536	Uno Batten Holder *	55.00	20/400
GM 3026	8536	Play Angle Holder *	58.00	20/400
GM 3027	8536	Play Batten Holder *	58.00	20/400
GM 3233	8536	Play Jumbo Batten Holder *	69.00	20/400
		*with advanced international interlock configuration		
PLATE TYPE LAMP HOLDERS				
GM 3224	8536	Helix Angle Holder *	79.00	20/300
GM 3225	8536	Helix Batten Holder *	79.00	20/300
		*with advanced international interlock configuration		
PLATE TYPE LAMP HOLDERS / CEILING ROSE				
GM 3220	8536	Apex Angle Holder *	74.00	20/300
GM 3221	8536	Apex Batten Holder *	74.00	20/300
GM 3223	8536	Apex Ceiling Rose	66.00	20/500
GM 3211	8536	Square Angle Holder	60.00	20/400
GM 3212	8536	Square Batten Holder	60.00	20/400
		* with auto safe lock		
CEILING ROSE / PENDANT HOLDER				
GM 3023	8536	Pilot Ceiling Rose *	43.00	20/600
GM 3024	8536	Jumbo Ceiling Rose *	51.00	20/400
GM 3028	8536	Play Ceiling Rose *	45.00	20/600
GM 3073	8536	Play Jumbo Ceiling Rose *	54.00	20/400
GM 3025	8536	Pendant Holder	44.00	20/600
		* with auto safe lock		
ROUND PLATES				
GM 1176	8538	Round Plate (dummy) - Size 3.5 Inch	11.00	50/1500
GM 1177	8538	Round Plate - Size 3.5 Inch	11.00	50/1500
GM 1186	8538	Medium Plate - Size 4.25 Inch	16.00	50/1500
GM 1179	8538	Fan Plate - Size 6.5 Inch	41.00	50/400

CODE	HSN CODE	ITEM	MRP ₹	STD./ MST. PKG.
2 PIN FLEX BOXES WITH HANDLE				
GM 3040	8537	Square 2 Pin Flex Box 5 Mtr. *	410.00	5/60
GM 3043	8537	Jewel 2 Pin Flex Box 5 Mtr. *	462.00	5/60
GM 3047	8537	G Flex 2 Pin Flex Box 5 Mtr. *	473.00	5/45
GM 3245	8537	Meridian 2 Pin Flex Box 5 Mtr. *	557.00	5/60
		* with handle, indicator & international socket		
3 PIN FLEX BOXES WITH HANDLE				
GM 3045	8537	Square 3 Pin Flex Box 4 Mtr. *	541.00	5/60
GM 3046	8537	Jewel 3 Pin Flex Box 4 Mtr. *	551.00	5/60
GM 3208	8537	Jewel 16A 3 Pin Flex Box 4 Mtr.* - With Circuit Breaker	1259.00	5/30
GM 3250	8537	Meridian 3 Pin Flex Box 4 Mtr. *	609.00	5/60
		* with handle, indicator & international socket		
2 PIN FLEX BOXES				
GM 3041	8537	Trio 2 Pin Flex Box 5 Mtr. *	394.00	5/60
GM 3042	8537	G Star 2 Pin Flex Box 5 Mtr. *	431.00	5/60
GM 3071	8537	Orbit 2 Pin Flex Box 5 Mtr. *	410.00	5/60
GM 3072	8537	Geo 2 Pin Flex Box 4.2 Mtr. *	383.00	5/60
GM 3066	8537	Geo 2 Pin Flex Box 8.2 Mtr. *	546.00	5/60
GM 3259	8537	Trio 2 Pin Flex Box 8.2 Mtr. *	524.00	5/60
GM 3014	8537	Orion 2 Pin Flex Box 4.2 Mtr. *	383.00	5/60
GM 3240	8537	Drei 2 Pin Flex Box 5 Mtr. *	483.00	5/60
		* with indicator & international socket		
3 PIN FLEX BOXES				
GM 3249	8537	Drei 3 Pin Flex Box 4 Mtr. *	557.00	5/60
GM 3093	8537	Geo 3 Pin Flex Box 5 Mtr. *	524.00	5/60
		* with indicator & international socket		



GM 3040

GM 3043



GM 3047

GM 3245



GM 3045

GM 3046



GM 3208

GM 3250



GM 3041

GM 3042

GM 3071



GM 3072

GM 3066

GM 3259



GM 3014

GM 3240



GM 3249

GM 3093

Ultra
SMOOTH
rotation



Security was never really an option at home.

SPIKE GUARDS & FLEX BOX

Your computer or your television is an important part of your home. And it must be protected at all times. What more do we say?



GM 3206



GM 3207



GM 6002



GM 3058



GM 3059



GM 3061



GM 3062



GM 3202



GM 3203



GM 3252



GM 3255



GM 3256

CODE	HSN CODE	ITEM	MRP ₹	STD./ MST. PKG.
EXTENSION CORDS / PARALLEL WIRE				
GM 3206	8537	G-on Mini 2 Pin Extension Cord 2.5 Mtr. *	369.00	5/60
GM 3207	8537	G-on Mini 3 Pin Extension Cord 1.5 Mtr. *	439.00	5/60
GM 6002	8537	Parallel Wire Link 5 Mtr. - With 2 Pin Plug & Pendant Holder * with indicator, safety shutter & 2 International sockets	204.00	10/100
SPIKE GUARDS				
GM 3058	8537	G-Power 4+1 Spike Guard with master switch, indicator, safety shutter, international sockets & surge protector	793.00	5/45
GM 3059	8537	G-Power 6+1 Spike Guard with master switch, indicator, safety shutter, international sockets & surge protector	971.00	5/30
GM 3061	8537	E-Book 4+4 Spike Guard with individual switch, with indicator, safety shutter, international sockets & surge protector	1049.00	5/45
GM 3062	8537	E-Book 6+1 Spike Guard with master switch, with indicator, safety shutter, international sockets & surge protector	977.00	5/30
GM 3202	8537	Spike Shield 4+1 Spike Guard with master switch, indicator, safety shutter, international sockets & surge protector	819.00	5/45
GM 3203	8537	Quadro 4+1 Spike Guard with master switch, indicator, safety shutter, international sockets & surge protector	761.00	5/45
GM 3252	8537	4SQ 4+1 Spike Guard with master switch, indicator, safety shutter, surge protector & 4 international sockets	803.00	5/45
GM 3255	8537	Lemoid 4+1 Spike Guard with master switch, indicator, surge protector & 4 international sockets	999.00	5/30
GM 3256	8537	Lemoid 6+1 Spike Guard with master switch, indicator, 6 international sockets & surge protector	1185.00	10/40

CODE	HSN CODE	ITEM	MRP ₹	STD./ MST. PKG.
SPIKE GUARDS / POWER STRIPS WITH USB				
GM 3204	8537	Quadro 4+4 Spike Guard with individual switch, indicator, safety shutter, surge protector, 3 international sockets & twin USB- 2.1A	1381.00	5/45
GM 3205	8537	Quadro 8+1 Spike Guard with master switch, indicator, safety shutter, surge protector, 7 international sockets & twin USB- 2.1A	1574.00	5/30
GM 3251	8537	4SQ 4+1 Spike Guard with master switch, indicator, safety shutter, surge protector, 3 international sockets & 2 USB- 2.1 A	1280.00	5/45
GM 3254	8537	Lemoid 4+1 Spike Guard with master switch, indicator, surge protector, 3 international sockets & 1 USB- 2.1 A	1240.00	10/60
GM 3258	8537	Lemoid 4+1 Spike Guard USB with Detachable TWIN USB - 2.1 A 3 international sockets, Master Switch & surge protector	1155.00	10/60
GM 3260	8537	Lemoid 4+1 Spike Guard USB with 3 USB - 2.1 A, 3 international sockets, master switch & surge protector	1280.00	10/60
GM 3044	8537	Saturn 5+1+1 Power Strip with master switch, indicator, safety shutter, 5 international sockets & twin USB- 2.1A	1523.00	5/45
POWER STRIPS				
GM 3201	8537	Spike Shield 2+2+1 Power Strip with master switch, indicator, safety shutter, 2 international sockets & 2 pin sockets	609.00	5/45
GM 3065	8537	Quadro 4+1 Power Strip with master switch, indicator, safety shutter, international sockets (5 Mtr.)	903.00	5/45
GM 3253	8537	I-Croft 4+1 Power Strip with master switch, indicator & 4 international sockets	588.00	5/45
GM 3060	8537	E-Book 4+1 Power Strip with master switch, indicator, safety shutter, international sockets	620.00	5/45
GM 3068	8537	Power Mate 4+1 Power Strip with master switch, indicator & international sockets	629.00	5/45
GM 3257	8537	Oooh 4+1 Power Strip with master switch, indicator & international sockets	629.00	5/45
GM 3246	8537	Saturn 6+1 Power Strip with master switch, indicator, safety shutter, & international sockets	998.00	5/45



GM 3204

GM 3205



GM 3251

GM 3254



GM 3258

GM 3260



GM 3044



GM 3201

GM 3065



GM 3253

GM 3060



GM 3068

GM 3257



GM 3246



Leave lasting Impressions.

DOORBELLS

Create the best impression on your guests with the exciting new range of doorbells. You are never short of a warm welcome with the wide range of doorbells to choose from.



GM 4001 GM 4002 GM 4003 GM 4004



GM 4005 GM 4006 GM 4007 GM 4008



GM 4009 GM 4010 GM 4011 GM 4012



GM 4014 GM 4015



GM 4026



GM 4041 GM 4042



GM 4075

CODE	HSN CODE	ITEM	MRP ₹	STD./ MST. PKG.
DING DONG DOORBELLS				
GM 4001	8531	Ultima *	199.00	5/120
GM 4002	8531	Spectra *	217.00	5/120
GM 4003	8531	Designer *	217.00	5/120
GM 4004	8531	Radius	193.00	5/120
GM 4005	8531	Alpha	193.00	5/120
GM 4006	8531	Phototrix	199.00	5/120
GM 4007	8531	Prime	193.00	5/120
GM 4008	8531	Strio *	217.00	5/120
GM 4009	8531	Vibro *	217.00	5/120
GM 4010	8531	Wavion *	217.00	5/120
GM 4011	8531	Resono *	223.00	5/120
GM 4012	8531	Tessa *	244.00	5/120
GM 4014	8531	Premio *	217.00	5/120
GM 4015	8531	Accord *	217.00	5/120

* stereophonic dindong bell

DIVINE MANTRA DOORBELLS				
GM 4026	8531	Gayatri Mantra	366.00	5/120
GM 4041	8531	Harmony -1 Mantra Bell - with 9 selectable mantras & flashing light	461.00	5/90
GM 4042	8531	Harmony -2 Mantra Bell* - with 9 selectable mantras & flashing light	461.00	5/90
GM 4075	8531	G - Code Multitune Mantra Bell - with dual speaker, 25 selectable mantras and flashing light	795.00	5/60

*Voice : Anuradha Paudwal

CODE	HSN CODE	ITEM	MRP ₹	STD/ MST. PKG.
SHLOKA EDGE GLOW DOORBELLS				
GM 4045	8531	Shloka Edge Glow Bell - Ganesha Mantra	398.00	5/120
GM 4046	8531	Shloka Edge Glow Bell - Shivji Mantra	398.00	5/120
GM 4047	8531	Shloka Edge Glow Bell - Gurur Brahma Mantra	398.00	5/120
GM 4048	8531	Shloka Edge Glow Bell - Tirupati Mantra	398.00	5/120
GM 4049	8531	Shloka Edge Glow Bell - Gurbani Mantra	398.00	5/120
GM 4050	8531	Shloka Edge Glow Bell - Gayatri Mantra	398.00	5/120



GM 4045

GM 4046



GM 4047

GM 4048



GM 4049

GM 4050

DIVINE MANTRA DOORBELLS				
GM 4063	8531	Divine Manta Doorbell - Ganesha *	429.00	5/120
GM 4064	8531	Divine Manta Doorbell - Gurur Brahma *	429.00	5/120
GM 4065	8531	Divine Manta Doorbell - Durga Chant *	429.00	5/120
GM 4066	8531	Divine Manta Doorbell - Shiva Chant *	429.00	5/120
GM 4067	8531	Divine Manta Doorbell - Gayatri Mantra *	429.00	5/120
GM 4068	8531	Divine Manta Doorbell - Navkar Mantra *	429.00	5/120
GM 4069	8531	Divine Manta Doorbell - Shani Mantra *	429.00	5/120
GM 4070	8531	Divine Manta Doorbell - Sai Chant *	429.00	5/120
GM 4071	8531	Divine Manta Doorbell - Laxmi Mantra *	429.00	5/120
* Voice : Anuradha Paudwal				



GM 4063

GM 4064

GM 4065



GM 4066

GM 4067

GM 4068



GM 4069

GM 4070

GM 4071



GM 4095



GM 4096



GM 4097



GM 4029



GM 4058



GM 4028



GM 4030



GM 4031



GM 4032



GM 4033



GM 4091



GM 4074



GM 4076



GM 4081



GM 4092



GM 4093



GM 4013

CODE	HSN CODE	ITEM	MRP ₹	STD./ MST. PKG.
PLUG IN CONTINUOUS MANTRAS				
GM 4095	8531	Vedanta Plug In Continuous Mantra *	435.00	5/120
GM 4096	8531	Nirvana Plug In Continuous Mantra *	435.00	5/120
GM 4097	8531	Aastha Plug In Continuous Mantra *	419.00	5/120
		* with 18 Mantras & LED		
MULTITUNE MUSICAL DOORBELLS				
GM 4029	8531	Wave Doorbell - with 32 selectable melodies & flashing light	541.00	5/120
GM 4058	8531	G-Tune Multi-tune - with selectable tunes, volume control & flashing light	1007.00	5/120
GM 4028	8531	Channel G - Multi-tune - with flashing light	398.00	5/120
GM 4030	8531	Ultra Musical Decor - double colour combination	398.00	5/120
GM 4031	8531	Sparkle- Electronic Duo-tune - with flashing light and choice of 2 different tunes	419.00	5/120
GM 4032	8531	I- Magic - Musical Chime - with flash flickering technology	376.00	5/90
GM 4033	8531	Rock 'n' Roll Dual Tune - with choice of 2 different tunes	313.00	10/200
GM 4091	8531	Torus Musical Multi-tune - with flash light and flash flickering technology	413.00	5/120
MULTITUNE MUSICAL DOORBELLS				
GM 4074	8531	I-Dot Musical Bell - with 5 different colours	366.00	5/120
GM 4076	8531	I-Wiz Musical Bell - with stereophonic sound	440.00	5/120
GM 4081	8531	G-Code Doorbell - with dual speaker, 21 selectable melodies & flashing light	742.00	5/60
MULTITUNE MUSICAL DOORBELLS				
GM 4092	8531	Groove - with stereophonic sound	398.00	5/120
GM 4093	8531	Celestia - with selectable melodies & flashing light	398.00	5/120
GM 4013	8531	Cuckoo Bird Chime - with Flashing Light	313.00	5/120

CODE	HSN CODE	ITEM	MRP ₹	STD/ MST. PKG.
WIRELESS DOORBELLS				
GM 4061	8531	Wave Wireless Digital - with remote, 32 selectable melodies & flashing light	1124.00	5/60
GM 4062	8531	Theme Wireless Digital - with remote, 32 selectable melodies & flashing light	1124.00	5/60
WIRELESS DOORBELLS				
GM 4088	8531	Zio Wireless Doorbell - with remote, 48 selectable melodies, volume control, shuffle function & flashing light	1124.00	5/60
GM 4089	8531	Auro Wireless Doorbell - with remote, 48 selectable melodies, volume control, shuffle function & flashing light	1124.00	5/60
GM 4078	8531	Tilt Wireless Doorbell with remote, 48 selectable melodies,	1049.00	5/60
GM 4079	8531	Musicano (MP3 Wireless Doorbell) -with in-built 128 MB storage & 32 multitunes, volume control, shuffle function. customize & store your own music. (supplied with usb cable for recording)	1834.00	5/60
GM 4044	8531	Glossia Multitune Doorbell with remote, volume control, 36 musical sounds, waterproof transmitter/IP44, 200 metre operating range & LED indicator for transmitter and receiver	975.00	5/60
GM 4098	8531	Jinglz Multitune Doorbell with remote, 30 selectable melodies, IP40	795.00	5/60
GM 4099	8531	Claria Multitune Doorbell - with remote, 30 selectable melodies, volume control, IP40	901.00	5/60
PLUG IN WIRELESS DOORBELLS				
GM 4087	8531	Vio Plug in Wireless Doorbells with remote, 32 selectable melodies, volume control, shuffle function & flashing light	1113.00	5/60
GM 4094	8531	Gusto Plug in Wireless Doorbells with remote & battery less, 32 selectable melodies, volume control, shuffle function & flashing light	1203.00	5/60



GM 4061

GM 4062



GM 4088

GM 4089



GM 4078

GM 4079



GM 4044

GM 4098



GM 4099



GM 4087

GM 4094



A guiding light in your home.

NIGHTLAMPS

Simple and easy. That is how the basic necessities at home should be designed. Plug and play night lamps that spread enough light for your needs in the dark.



GM 3030



GM 3034



GM 3029



GM 3031



GM 3032



GM 3033



GM 3035



GM 3036



GM 3037



GM 3038



GM 3075



GM 3089



GM 3247



GM 3231



GM 3232

CODE	HSN CODE	ITEM	MRP ₹	STD./ MST. PKG.
SENSOR NIGHT LAMPS				
GM 3030	9405	Sensor Night Lamp *	195.00	5/100
GM 3034	9405	Evox Night Lamp *	231.00	10/180
		* with auto sensing device & LED		
PLUG IN LED NIGHT LAMPS				
GM 3029	9405	Night Lamp	115.00	10/300
GM 3031	9405	Xoom Night Lamp	100.00	10/200
GM 3032	9405	Nano Night Lamp	105.00	10/200
GM 3033	9405	Inox Night Lamp - with switch	200.00	10/180
GM 3035	9405	Galaxy Night Lamp - with switch	189.00	10/180
GM 3036	9405	Focus Night Lamp	105.00	10/420
GM 3037	9405	Vega Night Lamp	90.00	10/200
GM 3038	9405	Prism Night Lamp	105.00	10/200
GM 3075	9405	Eco Lite - edge glow night lamp	189.00	10/180
GM 3089	9405	Planet G Night Lamp - with adjustable scroll for intensity of light	231.00	10/120
GM 3247	9405	Iris Night Lamp	221.00	10/120
BATTERY OPERATED LED LAMPS				
GM 3231	9405	Festivity Led Lamp (1 Pc.) *	160.00	5/120
GM 3232	9405	Festivity Led Lamp (2 Pcs.) *	310.00	5/100
		* Battery provided		

CODE	HSN CODE	ITEM	MRP ₹	STD/ MST. PKG.
DIVINE PLUG IN EDGE GLOW LED NIGHT LAMPS				
GM 3039	9405	Divine Edge Glow Night Lamp - with Two additional slides	210.00	10/120
GM 3081	9405	Divine - Shubham	168.00	10/250
GM 3082	9405	Divine - Holy	168.00	10/250
GM 3083	9405	Divine - Cianna	168.00	10/250
GM 3084	9405	Divine - Gurbani	168.00	10/250
VEDA PLUG IN EDGE GLOW LED NIGHT LAMPS				
GM 3226	9405	Veda- Shubham	242.00	5/100
GM 3227	9405	Veda - Holy	242.00	5/100
GM 3228	9405	Veda - Cianna	242.00	5/100
GM 3229	9405	Veda - Gurbani	242.00	5/100
AUSPICIA PLUG IN EDGE GLOW LED NIGHT LAMPS				
GM 3241	9405	Auspicia- Shubham	260.00	5/100
GM 3242	9405	Auspicia - Holy	260.00	5/100
GM 3243	9405	Auspicia -cianna	260.00	5/100
GM 3244	9405	Auspicia -gurbani	260.00	5/100
MOSQUITO REPELLER WITH LED AND NIGHT LAMP				
GM 3236	8516	Cuboid Mosquito Repeller	190.00	10/200
GM 3237	8516	Terminex Mosquito Repeller	190.00	10/200
GM 3238	8516	Strom Mosquito Repeller	185.00	10/200
GM 3239	8516	Xenon Mosquito Repeller	185.00	10/200
GM 3200	8516	Hummer Electronic Mosquito Repeller	175.00	10/200
TUBE LIGHT STARTER / PVC TAPE				
GM 3074	8536	G-Tech 20/40w Starter - with electronic circuit	16.00	50/1000
WR 7631	3919	FR Self Adhesive Pvc Electrical Insulation Tape 0.125 mm x 1.80 cm x 7 mtr	18.00	30/1200



GM 3039



GM 3081

GM 3082

GM 3083

GM 3084



GM 3226

GM 3227

GM 3228

GM 3229



GM 3241

GM 3242

GM 3243

GM 3244



GM 3236

GM 3237

GM 3238



GM 3239

GM 3200



GM 3074



WR 7631



Discovery your fantasy world.

DISNEY NIGHTLAMPS

Disney creates a wonderful fantasy world for your kids. The almost alive characters live with your kids, making their room a fantasy world.



GM 3111



GM 3113



GM 3114



GM 3115



GM 3117



GM 3120



GM 3121



GM 3122



GM 3123



GM 3124



GM 3125



GM 3127

CODE	HSN CODE	ITEM	MRP ₹	STD./ MST. PKG.
PLUG IN DISNEY BEETLE LED LAMPS WITH SWITCH				
GM 3111	9405	Snow White *	285.00	5/100
GM 3113	9405	Winnie The Pooh With Friends *	285.00	5/100
GM 3114	9405	Winnie The Pooh *	285.00	5/100
GM 3115	9405	Princess *	285.00	5/100
GM 3117	9405	Mickey *	285.00	5/100
GM 3120	9405	Cars *	285.00	5/100

* with ON/OFF switch

CODE	HSN CODE	ITEM	MRP ₹	STD./ MST. PKG.
PLUG IN DISNEY NEO SENSOR LED LAMPS				
GM 3121	9405	Snow White *	300.00	5/100
GM 3122	9405	Winnie The Pooh With Friends *	300.00	5/100
GM 3123	9405	Winnie The Pooh *	300.00	5/100
GM 3124	9405	Princess *	300.00	5/100
GM 3125	9405	Mickey *	300.00	5/100
GM 3127	9405	Cars *	300.00	5/100

* with auto sensing device

CODE	HSN CODE	ITEM	MRP ₹	STD./ MST. PKG.
DISNEY HANGING LAMPS				
GM 3129	9405	Princess *	1185.00	1/10
GM 3130	9405	Winnie The Pooh With Friends*	1185.00	1/10
GM 3131	9405	Mickey *	1185.00	1/10
		* with LED Lamp		



GM 3129



GM 3130



GM 3131

CODE	HSN CODE	ITEM	MRP ₹	STD./ MST. PKG.
DISNEY TABLE LAMPS				
GM 3133	9405	Princess *	970.00	1/10
GM 3134	9405	Winnie The Pooh With Friends *	970.00	1/10
GM 3135	9405	Mickey *	970.00	1/10
		* with LED Lamp		



GM 3133



GM 3134



GM 3135

CODE	HSN CODE	ITEM	MRP ₹	STD./ MST. PKG.
PLUG IN DISNEY JOLLY LED LAMPS				
GM 3138	9405	Snow White With Friends	285.00	5/100
GM 3139	9405	Winnie The Pooh With Friends	285.00	5/100
GM 3142	9405	Cindrella	285.00	5/100
GM 3143	9405	Mickey	285.00	5/100
GM 3146	9405	Cars	285.00	5/100



GM 3138



GM 3139



GM 3142



GM 3143



GM 3146



GM 3172



GM 3173



GM 3174



GM 3175



GM 3176



GM 3177



GM 3178



GM 3154



GM 3155



GM 3156



GM 3157



GM 3158



GM 3159



GM 3160



GM 3161



GM 3162



GM 3163



GM 3164

CODE	HSN CODE	ITEM	MRP ₹	STD./ MST. PKG.
PLUG IN DISNEY ASTRO LED LAMPS				
GM 3172	9405	Snow White With Friends	300.00	5/100
GM 3173	9405	Winnie The Pooh With Friends	300.00	5/100
GM 3174	9405	Cindrella	300.00	5/100
GM 3175	9405	Mickey	300.00	5/100
GM 3176	9405	Cars	300.00	5/100
GM 3177	9405	Avengers	300.00	5/100

PLUG IN DISNEY FLINT LED LAMPS				
GM 3178	9405	Snow White With Friends	390.00	5/100
GM 3154	9405	Winnie The Pooh With Friends	390.00	5/100
GM 3155	9405	Cindrella	390.00	5/100
GM 3156	9405	Mickey	390.00	5/100
GM 3157	9405	Cars	390.00	5/100
GM 3158	9405	Avengers	390.00	5/100

PLUG IN DISNEY TRIGO LED LAMPS				
GM 3159	9405	Snow White With Friends	370.00	5/100
GM 3160	9405	Winnie The Pooh With Friends	370.00	5/100
GM 3161	9405	Cindrella	370.00	5/100
GM 3162	9405	Mickey	370.00	5/100
GM 3163	9405	Cars	370.00	5/100
GM 3164	9405	Avengers	370.00	5/100

CODE	HSN CODE	ITEM	MRP ₹	STD./ MST. PKG.
PLUG IN DISNEY GLITZY EDGE GLOW LED LAMPS				
GM 3150	9405	Winnie The Pooh	265.00	5/100
GM 3151	9405	Mickey	265.00	5/100
GM 3152	9405	Cars	265.00	5/100
GM 3153	9405	Princess	265.00	5/100



GM 3150



GM 3151



GM 3152



GM 3153

PLUG IN DISNEY MARVELOUS EDGE GLOW LED LAMPS				
GM 3165	9405	Winnie The Pooh	300.00	5/100
GM 3166	9405	Mickey	300.00	5/100
GM 3167	9405	Cars	300.00	5/100
GM 3168	9405	Princess	300.00	5/100
GM 3169	9405	Cindrella	300.00	5/100
GM 3170	9405	Avengers	300.00	5/100



GM 3165



GM 3166



GM 3167



GM 3168



GM 3169



GM 3170

SWAROVSKI LED NIGHT LAMP				
GM 3171	9405	Swarovski - Dazzline	650.00	5/100



GM 3171



Experience a perfect world

SWITCHES & ACCESSORIES

Where you live becomes your world. This world within your home caters to every need of yours letting you live a safe and a comfortable life. G-Home range of switches and accessories provides you with all those essentials you would need to experience a perfect world, in the confines of your home.



GM 8001



GM 8002



GM 8003



GM 8004



GM 8101



GM 8102



GM 8103



GM 8104



GM 8111



GM 8112



GM 8113



GM 8114



GM 8017



GM 8018



GM 8020



GM 8021



GM 8023



GM 8024



GM 8026



GM 8027



GM 8029



GM 8030

CODE	HSN CODE	ITEM	MRP ₹	STD./ MST. PKG.
VEDA 10AX SWITCHES / INDICATOR				
GM 8001	8536	1 Way Switch	23.00	20/1200
GM 8002	8536	2 Way Switch	34.00	20/1200
GM 8003	8536	Bell Push	34.00	20/1200
GM 8004	8536	Indicator	34.00	20/1200
VAYU 10AX SWITCHES / INDICATOR				
GM 8101	8536	1 Way Switch	22.50	20/1200
GM 8102	8536	2 Way Switch	33.00	20/1200
GM 8103	8536	Bell Push	33.00	20/1200
GM 8104	8536	Indicator	33.00	20/1200
VYOMA 10AX SWITCHES / INDICATOR				
GM 8111	8536	1 Way Switch	22.50	20/1200
GM 8112	8536	2 Way Switch	33.00	20/1200
GM 8113	8536	Bell Push	33.00	20/1200
GM 8114	8536	Indicator	33.00	20/1200
6A / 10A SOCKETS / 13A INTERNATIONAL SOCKET				
GM 8017	8536	6A 2 Pin Socket - with safety shutter	37.00	20/1200
GM 8018	8536	6A 2 Pin Socket	36.00	20/1200
GM 8020	8536	10A 2 In 1 Socket	39.00	10/600
GM 8021	8536	13A International Socket - with safety shutter	62.00	10/600
TV ANTENNA SOCKETS				
GM 8023	8536	Mini Tv Antenna Socket	47.00	20/1200
GM 8024	8536	Medium Tv Antenna Socket	50.00	20/1000
ELECTRONIC DIMMERS / REGULATORS				
GM 8026	8533	Mini Dimmer	221.00	10/500
GM 8027	8533	Medium Dimmer	234.00	10/300
GM 8029	8414	Electronic Type Mini 4 Step Fan Regulator (full Rotary)	313.00	10/500
GM 8030	8414	Electronic Type 5 Step Fan Regulator (full Rotary)	342.00	10/300

CODE	HSN CODE	ITEM	MRP ₹	STD/ MST. PKG.
RJ-11 TELEPHONE JACKS / KIT - KAT FUSE				
GM 8034	8536	Mini 2 Line Tel Jack	84.00	20/1200
GM 8035	8536	Medium 4 Line Tel Jack	99.00	20/1000
GM 8039	8536	Kit-Kat Fuse - (Suitable for 10A & 15A)	67.00	20/600
VEDA 10A SWITCH SOCKET COMBINED				
GM 8042	8536	10A S.S. Combined - with indicator	90.00	10/300
GM 8043	8536	10A S.S. Combined - with indicator & gang box	121.00	10/300
GM 8055	8536	8 In One 10A S.S. Combined - with gang box	262.00	5/100
VEDA 20A SWITCHES				
GM 8044	8536	1 Way Switch	127.00	10/300
GM 8045	8536	2 Way Switch	146.00	10/300
VEDA 20A GAMA SWITCH / 6 & 16A UNI. SOCKET				
GM 8046	8536	Gama 1 Way Switch - with indicator	150.00	10/300
GM 8048	8536	6 & 16A Universal Socket - with safety shutter	127.00	10/300
VEDA 6 & 16A 3 IN ONE				
GM 8050	8536	3 In One Universal S.S. Combined - with safety shutter	198.00	5/150
GM 8049	8536	3 In One Universal S.S. Combined - with safety shutter & gang box	246.00	5/150



GM 8034



GM 8035



GM 8039



GM 8042



GM 8043



GM 8055



GM 8044



GM 8045



GM 8046



GM 8048



GM 8050



GM 8049



GM 8051



GM 8052



GM 8053



GM 8054



GM 8144



GM 8145



GM 8148



GM 8150



GM 8149



GM 8151



GM 8152



GM 8095



GM 8220



GM 8221

CODE	HSN CODE	ITEM	MRP ₹	STD./ MST. PKG.
VEDA 6 & 16A 5 IN ONE				
GM 8051	8536	5 In One Universal SS.Combined -with fuse, indicator & safety shutter	271.00	5/100
GM 8052	8536	5 In One Universal SS.Combined -with fuse, indicator, safety shutter & gang box	330.00	5/100
VEDA 32A DP SWITCH / 6A GAMA BELL PUSH				
GM 8053	8536	32A DP. Switch - with indicator	239.00	10/300
GM 8054	8536	6A Gama Bell Push - with indicator	110.00	10/300
VAYU 20A SWITCH / 6 & 16A SOCKET (PORCELAIN BASE)				
GM 8144	8536	1 Way Switch	127.00	10/300
GM 8145	8536	2 Way Switch	144.00	10/300
GM 8148	8536	6 & 16A Universal Socket - with safety shutter	127.00	10/300
GM 8344	8536	1 Way Switch	127.00	10/300
GM 8348	8536	6 & 16A Universal Socket	139.00	10/300
VAYU 6 & 16A 3 IN ONE (PORCELAIN BASE)				
GM 8150	8536	3 In One Universal S.S. Combined - with safety shutter	197.00	5/150
GM 8149	8536	3 In One Universal SS. Combined - with safety shutter & gang box	246.00	5/150
GM 8350	8536	3 In One Universal S.S. Combined	193.00	5/150
GM 8349	8536	3 In One Universal SS. Combined - with gang box	240.00	5/150
VAYU 6 & 16A 5 IN ONE (PORCELAIN BASE)				
GM 8151	8536	5 In One Universal S.S. Combined - with fuse indicator & safety shutter	273.00	5/100
GM 8152	8536	5 In One Universal SS. Combined - with fuse, indicator, safety shutter & gang box	334.00	5/100
GM 8351	8536	5 In One Universal SS. Combined - with fuse & indicator	273.00	5/100
GM 8352	8536	5 In One Universal SS. Combined - with fuse, indicator & gang box	332.00	5/100
SURFACE GANG BOX / LAMP HOLDERS				
GM 8095	8536	Surface Box - (suitable for 20A switches, 20A gama switch, gama bell push 6 & 16A sockets & 32A DP)	37.00	10/300
GM 8220	8536	Angle Holder	47.00	20/400
GM 8221	8536	Batten Holder	47.00	20/400

CODE	HSN CODE	ITEM	MRP ₹	STD./ MST. PKG.
CEILING ROSES				
GM 8223	8536	Pilot Ceiling Rose - with auto safe lock	40.00	20/600
GM 8224	8536	Jumbo Ceiling Rose - with auto safe lock	45.00	20/400
ADAPTOR / BED SWITCH / 2 PIN PLUG / SOCKET				
GM 8205	8536	Adaptor	28.00	30/900
GM 8206	8536	Bed Switch	55.00	20/800
GM 8252	8536	2 Pin Plug	26.00	50/1200
GM 8254	8536	2 Pin Plug/socket	53.00	50/800
3 PIN PLUG TOPS / GLOW 3 PIN PLUG TOPS				
GM 8201	8536	6A 3 Pin Top	67.00	20/600
GM 8202	8536	16A 3 Pin Top	91.00	10/300
GM 8203	8536	6A Glow 3 Pin Top	69.00	20/600
GM 8204	8536	16A Glow 3 Pin Top	98.00	10/300
3 PIN PLUG ADAPTOR				
GM 8248	8536	3 Pin Multi Plug Adaptor	146.00	10/180
GM 8249	8536	3 Pin Universal Adaptor - with indicator	141.00	10/180
16A ROUND TOP / SOCKET (BAKELITE)				
GM 8071	8536	3 Pin Round Top (Black)	121.00	10/100
GM 8072	8536	3 Pin Round Socket (Black) (porcelain Base)	124.00	10/100
32A D.P. SWITCH / MINI 32A D.P. SWITCH (PORCELAIN BASE)				
GM 8091	8536	Surface DP Switch - with indicator	225.00	5/100
GM 8092	8536	Flush DP Switch - with indicator	225.00	5/100
GM 8093	8536	Mini Surface DP Switch - with indicator	213.00	5/100
GM 8094	8536	Mini Flush DP Switch - with indicator	213.00	5/100



GM 8223

GM 8224



GM 8205

GM 8206

GM 8252

GM 8254



GM 8201

GM 8202

GM 8203

GM 8204



GM 8248

GM 8249



GM 8071

GM 8072



GM 8091

GM 8092

GM 8093

GM 8094



Evolution is inevitable

SWITCHES & ACCESSORIES

Each passing day a new idea takes life that transforms the present into something better. A concept that evolves with time and stands the test of time. That is G-Era. It is just all about that newness to things. It is the joy of offering new solutions to all the spatial needs within a home. G-Era is about the new, which is you.



GM 8501



GM 8502



GM 8503



GM 8504



GM 8505



GM 8506



GM 8507



GM 8508



GM 8509



GM 8510



GM 8511



GM 8512



GM 8518



GM 8520



GM 8521



GM 8523



GM 8524



GM 8526



GM 8527



GM 8529



GM 8530

CODE	HSN CODE	ITEM	MRP ₹	STD./ MST. PKG.
ERION 10AX SWITCHES / INDICATOR				
GM 8501	8536	1 Way Switch	23.50	20/1200
GM 8502	8536	2 Way Switch	33.00	20/1200
GM 8503	8536	Bell Push	33.00	20/1200
GM 8504	8536	Indicator	33.00	20/1200

EVON 10AX SWITCHES / INDICATOR				
GM 8505	8536	1 Way Switch	22.50	20/1200
GM 8506	8536	2 Way Switch	33.00	20/1200
GM 8507	8536	Bell Push	33.00	20/1200
GM 8508	8536	Indicator	33.00	20/1200

EVA 10AX SWITCHES / INDICATOR				
GM 8509	8536	1 Way Switch	22.50	20/1200
GM 8510	8536	2 Way Switch	31.00	20/1200
GM 8511	8536	Bell Push	31.00	20/1200
GM 8512	8536	Indicator	31.00	20/1200

6A / 10A SOCKETS				
GM 8518	8536	6A 2 Pin Socket	34.00	20/1200
GM 8520	8536	10A 2 In 1 Socket	40.00	10/600
GM 8521	8536	10A 5 Pin Multi Socket	44.00	10/600

TV ANTENNA SOCKETS				
GM 8523	8536	Mini Tv Antenna Socket *	44.00	20/600
GM 8524	8536	Medium Tv Antenna Socket *	48.00	10/600

* with cord grip configuration

ELECTRONIC DIMMERS / FAN REGULATORS				
GM 8526	8533	Mini Dimmer	211.00	10/450
GM 8527	8533	Medium Dimmer	222.00	10/300
GM 8529	8414	Electronic Type Mini 4 Step Fan Regulator (Full Rotary)	294.00	10/450
GM 8530	8414	Electronic Type 5 Step Fan Regulator (Full Rotary)	323.00	10/300

CODE	HSN CODE	ITEM	MRP ₹	STD./ MST. PKG.
TELEPHONE JACK / KIT-KAT FUSE				
GM 8534	8536	2 Line Jack - with enclosure	74.00	20/600
GM 8535	8536	Med 2 Line Jack - with enclosure	78.00	20/600
GM 8539	8536	10A Kit Kat Fuse	53.00	10/300
GM 8540	8536	15A Kit Kat Fuse	65.00	10/300



GM 8534 GM 8535 GM 8539 GM 8540

6A SWITCH SOCKET COMBINED				
GM 8542	8536	6A S.S. Combined - with indicator	92.00	10/160
GM 8543	8536	6A S.S. Combined - with indicator & gang box	108.00	10/160



GM 8542 GM 8543

ERION 16AX SWITCHES / 6 & 16A UNI. SOCKET				
GM 8644	8536	16AX 1 Way Switch	127.00	10/200
GM 8645	8536	16AX 2 Way Switch	146.00	10/200
GM 8648	8536	6 & 16A Universal Socket	129.00	10/200



GM 8644 GM 8645 GM 8648

ERION 3-IN-ONE				
GM 8650	8536	3-in-one Universal S.S. Combined	190.00	5/100
GM 8649	8536	3-in-one Universal S.S. Combined - with gang box	232.00	5/100



GM 8650 GM 8649

ERION 5-IN-ONE				
GM 8651	8536	5-in-one Universal S.S. Combined - with fuse & indicator	267.00	5/60
GM 8652	8536	5-in-one Universal S.S. Combined - with fuse, indicator & gang box	304.00	5/60



GM 8651 GM 8652

EVON 16AX SWITCHES				
GM 8544	8536	16AX 1way Switch	127.00	10/200
GM 8545	8536	16AX 2way Switch	146.00	10/200



GM 8544 GM 8545



GM 8548



GM 8553



GM 8550



GM 8549



GM 8570



GM 8569



GM 8551



GM 8552



GM 8571



GM 8572

CODE	HSN CODE	ITEM	MRP ₹	STD./ MST. PKG.
EVON 6 & 16A UNI. SOCKET / DP SWITCH				
GM 8548	8536	6 & 16A Universal Socket - with safety shutter	131.00	10/200
GM 8553	8536	32A DP Switch - with indicator	228.00	20/200
EVON 3-IN-ONE				
GM 8550	8536	3-in-one Universal S.S. Combined - with safety shutter	190.00	5/100
GM 8549	8536	3-in-one Universal S.S. Combined - with safety shutter & gang box	232.00	5/100
GM 8570	8536	3-in-one Universal S.S. Combined	190.00	5/100
GM 8569	8536	3-in-one Universal S.S. Combined - with gang box	232.00	5/100
EVON 5-IN-ONE				
GM 8551	8536	5-in-one Universal S.S. Combined - with fuse, indicator & safety shutter	267.00	5/60
GM 8552	8536	5-in-one Universal S.S. Combined - with fuse, indicator, safety shutter & gang box	304.00	5/60
GM 8571	8536	5-in-one Universal S.S. Combined - with fuse & indicator	267.00	5/100
GM 8572	8536	5-in-one Universal S.S. Combined - with fuse, indicator, safety shutter & gang box	304.00	5/60

CODE	HSN CODE	ITEM	MRP ₹	STD./ MST. PKG.
TELEPHONE JACK / KIT-KAT FUSE				
GM 8531	8536	Pilot Ceiling Rose	34.00	20/600
GM 8532	8536	Jumbo Ceiling	40.00	20/400
LAMP HOLDERS				
GM 8560	8536	Angle Holder	39.00	20/400
GM 8561	8536	Batten Holder	39.00	20/400
GM 8562	8536	Pendant Holder	35.00	30/600
GM 8533	8536	Roter Holder (pair)	31.00	48/960
PLUG TOPS				
GM 8601	8536	6A 3 Pin Top	70.00	20/600
GM 8602	8536	16A 3 Pin Top	105.00	10/300
2 PIN / 3 PIN PLUGS ADAPTOR				
GM 8563	8536	2 Pin Multi Plug	45.00	40/960
GM 8564	8536	3 Pin Multi Plug	73.00	40/800
6A SURFACE SWITCH / BELL PUSH				
GM 8565	8536	6A Surface 1 Way Switch	61.00	20/600
GM 8566	8536	6A Surface Bell Push	75.00	20/600



GM 8531



GM 8532



GM 8560



GM 8561



GM 8562



GM 8533



GM 8601



GM 8602



GM 8563



GM 8564



GM 8565



GM 8566



GM 8701



GM 8702



GM 8703



GM 8704



GM 8705



GM 8706



GM 8707



GM 8708



GM 8718



GM 8720



GM 8723



GM 8724



GM 8726



GM 8727



GM 8729



GM 8730



GM 8734



GM 8739



GM 8740

CODE	HSN CODE	ITEM	MRP ₹	STD./ MST. PKG.
CERA 10AX SWITCHES / INDICATOR				
GM 8701	8536	1 Way Switch	22.00	20/1200
GM 8702	8536	2 Way Switch	33.00	20/1200
GM 8703	8536	Bell Push	33.00	20/1200
GM 8704	8536	Indicator	33.00	20/1200
CIVIA 10AX SWITCHES / INDICATOR				
GM 8705	8536	1 Way Switch	22.00	20/1200
GM 8706	8536	2 Way Switch	33.00	20/1200
GM 8707	8536	Bell Push	33.00	20/1200
GM 8708	8536	Indicator	33.00	20/1200
6A / 10A SOCKETS				
GM 8718	8536	6A 2 Pin Socket	32.00	20/1200
GM 8720	8536	10A 2 In 1 Socket	42.00	20/600
TV ANTENNA SOCKETS				
GM 8723	8536	Mini Tv Antenna Socket *	37.00	20/1200
GM 8724	8536	Medium Tv Antenna Socket *	46.00	20/600
		* with cord-grip configuration		
ELECTRONIC DIMMERS / FAN REGULATORS				
GM 8726	8533	Mini Dimmer	208.00	10/450
GM 8727	8533	Medium Dimmer	222.00	10/300
GM 8729	8414	Electronic Type Mini 4 Step Fan Regulator (Full Rotary)	304.00	10/450
GM 8730	8414	Electronic Type 5 Step Fan Regulator (Full Rotary)	330.00	10/300
TELEPHONE JACK / KIT KAT FUSE				
GM 8734	8536	2 Line Tel Jack	77.00	20/600
GM 8739	8536	10A Kit Kat Fuse	57.00	10/300
GM 8740	8536	15A Kit Kat Fuse	63.00	10/300

CODE	HSN CODE	ITEM	MRP ₹	STD./ MST. PKG.
CERA 6A SWITCH SOCKET COMBINED				
GM 8742	8536	6A S.S. Combined	72.00	10/160
GM 8743	8536	6A S.S. Combined - with gang box	84.00	10/160
CERA 16AX. SWITCHES / 6 & 16A UNI. SOCKET				
GM 8744	8536	16AX 1 Way Switch	110.00	10/200
GM 8745	8536	16AX 2 Way Switch	122.00	10/200
GM 8748	8536	6 & 16A Universal Socket	116.00	5/100
CERA 3-IN-ONE				
GM 8750	8536	3-in-one Universal S.S. Combined	176.00	5/100
GM 8749	8536	3-in-one Universal S.S. Combined - with gang box	217.00	5/100
CERA 5-IN-ONE				
GM 8751	8536	5-in-one Universal S.S. Combined - with fuse & indicator	248.00	5/60
GM 8752	8536	5-in-one Universal S.S. Combined - with fuse, indicator & gang box	297.00	5/60
CIVIA 16AX. SWITCHES				
GM 8844	8536	16AX 1 Way Switch	111.00	10/200
GM 8845	8536	16AX 2 Way Switch	120.00	10/200



GM 8742



GM 8743



GM 8744



GM 8745



GM 8748



GM 8750



GM 8749



GM 8751



GM 8752



GM 8844



GM 8845



GM 8850



GM 8849



GM 8851



GM 8852



GM 8944



GM 8945



GM 8948



GM 8950



GM 8949



GM 8951



GM 8952



GM 8960



GM 8961



GM 8962

CODE	HSN CODE	ITEM	MRP ₹	STD./ MST. PKG.
CIVIA 3-IN-ONE				
GM 8850	8536	3-in-one Universal S.S. Combined	176.00	5/100
GM 8849	8536	3-in-one Universal S.S. Combined - with gang box	217.00	5/100
CIVIA 5-IN-ONE				
GM 8851	8536	5-in-one Universal S.S. Combined - with fuse & indicator	248.00	5/60
GM 8852	8536	5-in-one Universal S.S. Combined - with fuse, indicator & gang box	297.00	5/60
ECCO 20AMP SWITCHES / 6 & 16A UNI. SOCKET				
GM 8944	8536	20 Amp 1 Way Switch	132.00	10/120
GM 8945	8536	20 Amp 2 Way Switch	144.00	10/120
GM 8948	8536	6 & 16A Universal Socket	140.00	10/120
ECCO 3-IN-ONE				
GM 8950	8536	3-in-one Universal S.S. Combined	223.00	5/60
GM 8949	8536	3-in-one Universal S.S. Combined - with gang box	281.00	5/60
ECCO 5-IN-ONE				
GM 8951	8536	5-in-one Universal S.S. Combined - with fuse & indicator	319.00	5/60
GM 8952	8536	5-in-one Universal S.S. Combined - with fuse, indicator & gang box	383.00	5/60
ECCO LAMP HOLDERS				
GM 8960	8536	Angle Holder	40.00	20/400
GM 8961	8536	Batten Holder	40.00	20/400
GM 8962	8536	Pendant Holder	35.00	30/600

Simple yet elegant







Our exclusive experience centres

INDIA

Mumbai

Andheri

G-6, Laxmi Industrial Estate,
Opp. Laxmi Chhaya Hotel,
New Link Road, Andheri (W),
Mumbai - 400 053, Maharashtra.
Email: info@gmmodular.com
Contact: +918879918221.

Lohar Chawl

Shop No.1 Plot No. 151/153,
Bhabha Building, Lohar Chawl,
Mumbai - 400 002, Maharashtra.
Email: info@gmmodular.com
Contact: 022 2206 6545.

Bengaluru

460/ 20/ 1, 30th Cross,
8th B Main Road, 4th Block,
Beside Jain Temple, Jayanagar,
Bengaluru - 560 011, Karnataka.
Email: info@gmmodular.com
Contact: 080 4097 1188.

Belgaum

Shop No. 571, Bhati Tower,
Patil Galli, Belgaum - 590 001,
Karnataka.
Email: info@gmmodular.com
Contact: +91 99453 33107.

Hyderabad

No. 5-5-84/87, Shop No. 2&3,
Kalpakunj Apartment, Jambaug,
Hyderabad - 500 012, Telangana.
Email: info@gmmodular.com
Contact: 040 2473 4545.

Vijayawada

Shop no: 15 -18, K. S Vyas Complex,
Opp. Indira Gandhi Municipal
Stadium,
MG Road, Vijayawada - 520 010,
Andhra Pradesh.
Email: info@gmmodular.com
Contact: +91 86624 99945

Jalore

Near Kanchangiri Jain Temple,
Opp. Haridev Joshi Circle,
Bagoda Road, Jalore - 343 001,
Rajasthan.
Email: info@gmmodular.com
Contact: 02973-222288
+91 79769 79283

Bhilwara

G-4, Govindram Commercial Hub,
Old RTO Road, Bhilwara - 311 001,
Rajasthan.
Email: info@gmmodular.com
Contact: +91 89550 48560

Calicut

GM Avenue, 2nd Floor,
Red Cross Road,
Calicut 673 032, Kerala.
Email: info@gmmodular.com
Contact: 049 5277 3500.

Noida

C-161, Sector 63,
Near Hindustan Times Office,
Noida, Uttar Pradesh-201301
Email: info@gmmodular.com
Contact: 0120-4562087.

Kolkata

39/40, Ezra Street, Ground Floor,
Kolkata - 700 001, West Bengal.
Email: info@gmmodular.com
Contact: +91 33406 02048.

Ranchi

Mahavir Chowk, Upper Bazar,
Ranchi - 834 001, Jharkhand.
Email: info@gmmodular.com
Contact: 065 1355 1309
+91 94715 55599.

Tirunelveli

48, Raja Building,
Tirunelveli - 627 001,
Tamil Nadu.
Email: info@gmmodular.com
Contact: +91 94431 51008.

Coimbatore

22, Mill Road, Below ICICI Bank,
Coimbatore - 641 001,
Tamil Nadu.
Email: info@gmmodular.com
Contact: +91 99523 07025.

Puducherry

No. 298, J.N. Street,
Opp. to Sony Centre Showroom,
Puducherry - 605001,
Email: info@gmmodular.com
Contact: 04134500222.

UAE

Dubai

GMM Electricals LLC.,
Al Owais Business Tower,
Mezzanine Floor, Shop No-14,
Baniyas Street, Deira-Dubai, UAE.
Email: vishal.kothari@gmmodular.com
Contact: +971503786596



Giving you our best

GM has been extending innovative technology and luxury experiences for more than two decades. Our years of experience and expertise provide invaluable benefits for our production facility in Mumbai as well as in close co-operation with our global suppliers. It is of vital importance to us that we only work with suppliers that share our commitment to high quality. That is why our association has always been with talented, creative designers who have a responsible attitude towards design. And that is why we carefully select our suppliers so that we can work closely with them and supervise the whole production affair.

To achieve a perfect balance between carefully selected raw materials, beautiful design, functionality and good value is our moto. Every little piece, detail, line and material has been meticulously considered to ensure that the end result will work wonders in your home.

The entire GM product range catalogue can be found online on our website www.gmmodular.com.

You can follow GM on Facebook, Twitter, Instagram, YouTube and LinkedIn.

Copyright© 2020 GM

Concept, Design, Product Visualization
GM Modular Pvt. Ltd.

Printing
Mumbai, India.

Possible colour variations in product images in the catalogue

GM MODULAR PVT. LTD
Tel: 91-022-66790623
Fax: 91-022-66790624
Email: info@gmmodular.com
www.gmmodular.com
Customer Care No.: 1800 209 1215



GM PVT JUL 21

